

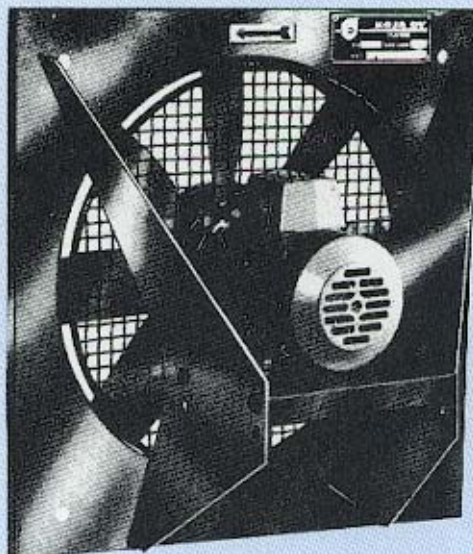

FPK-Aksiaalipuhaltimet

Sovitus 1

Seinään asennettu puhallin.
Poistopuhallin toimii yleensä
vapaapuhalluksen pisteessä.



Sovitus 6

Kanaviston osaksi: imu- tai painepuolelle.

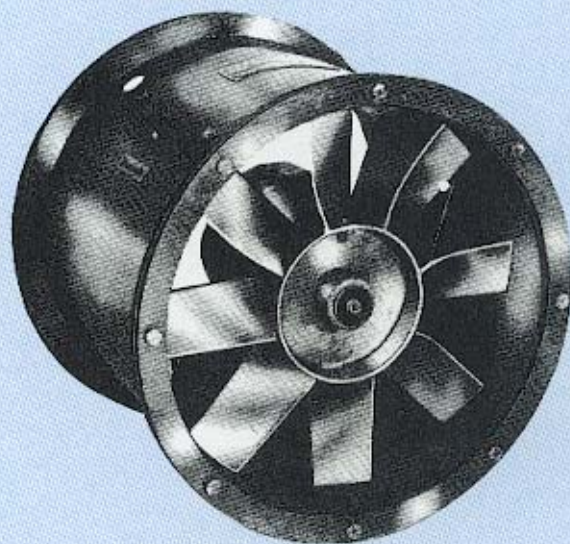

Teräslevyrakenteinen runko, joka on maalattu.
Potkuri on korroosionkestävää alumiinia. Dynaamisesti tasapainotettu.

Ominaiskäyrästä on laadittu lämpötilalle $t = 20^{\circ}\text{C}$ ($\rho = 1,2 \text{ kg/m}^3$). Suurin sallittu ilman lämpötila on 40°C , normaalilla moottoritoimituksella.

Hyvä hyötysuhde.

Puhaltimen pyöriessä väärinpäin, tilavuusvirta pienenee 70 % :iin. Tehontarve tulee olemaan pienempi kuin puhaltimen pyöriessä oikeinpäin.

KOJA

VALMISTAJA:

Koja Oy
PL 351, 33101 TAMPERE
Puh. (931) 652 511

MYynti:

Koja Oy
PL 351
33101 TAMPERE
Puh. (931) 652 330
Telefax (931) 652 723

Koja Oy
Ohrahuhdantie 2 A
00680 HELSINKI
Puh. (90) 752 2055
Telefax (90) 728 7758

Koja Oy
Kajaaninkatu 28 B 16
90100 Oulu
Puh. (981) 229 444
Telefax (981) 229 459



FPK-Aksiaalipuhaltimet

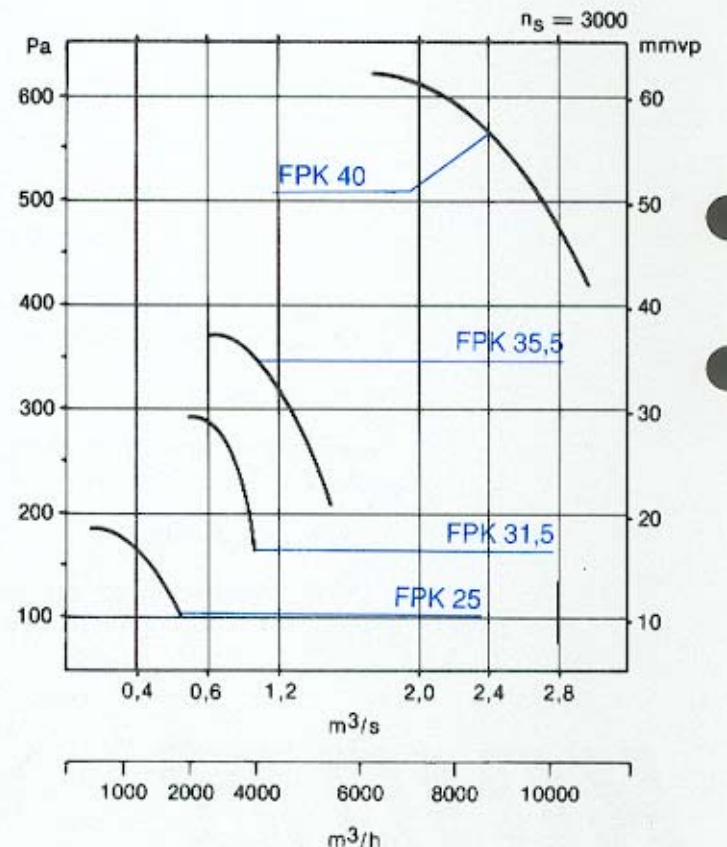
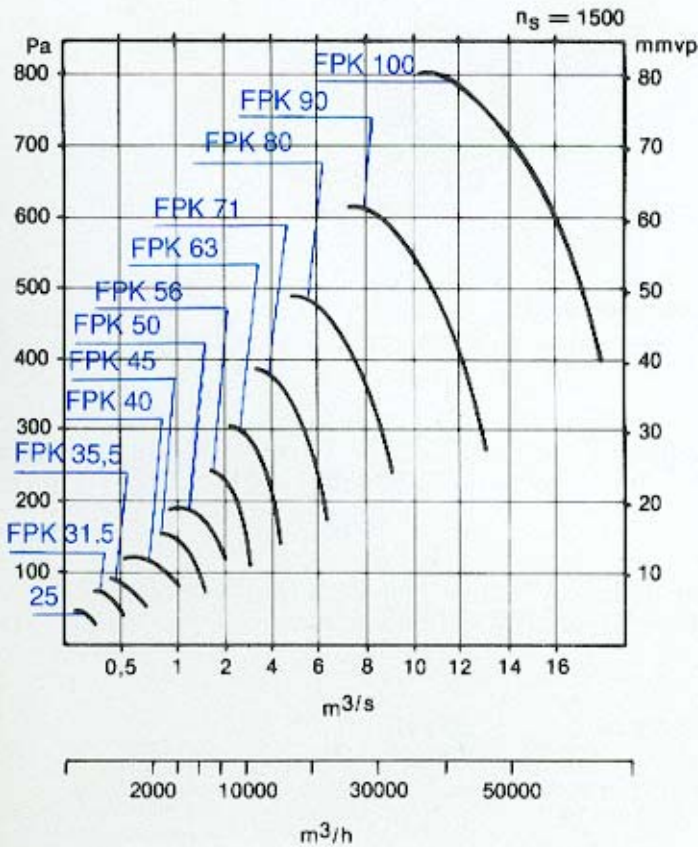
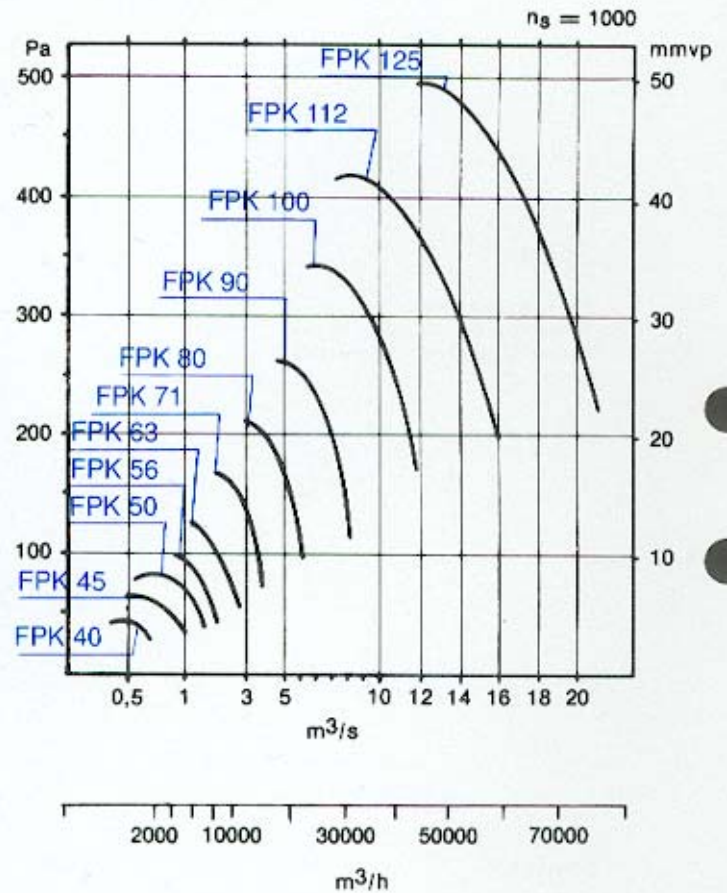
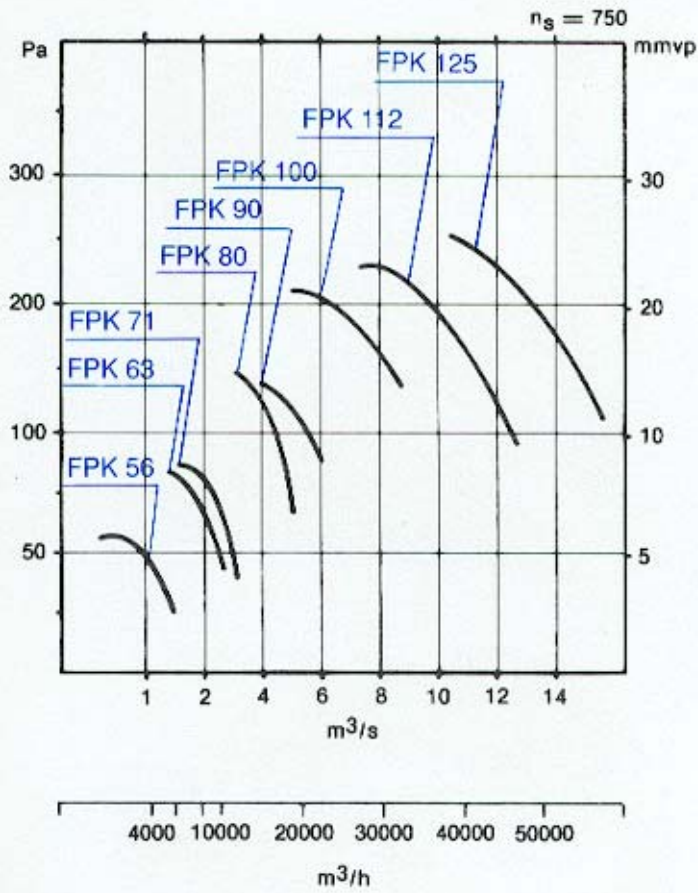



FPK-Ominaiskäyrät

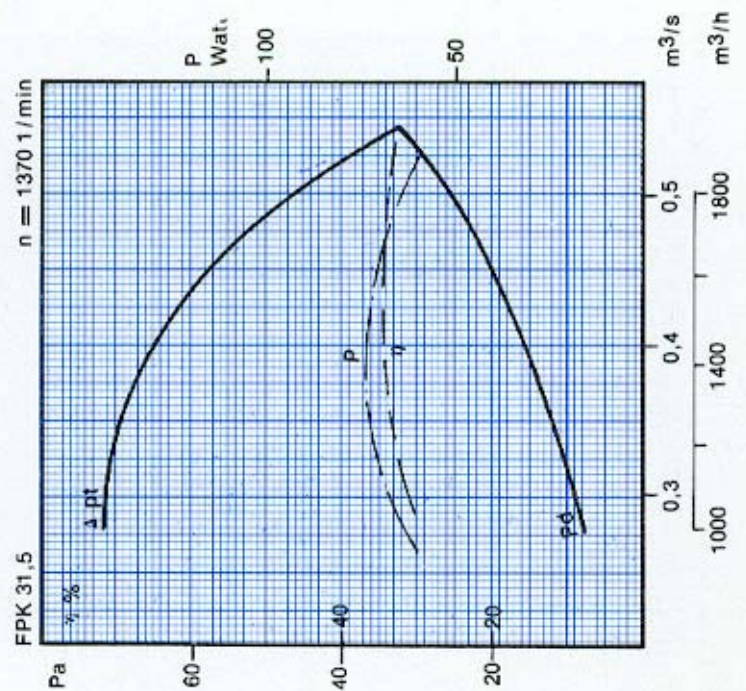
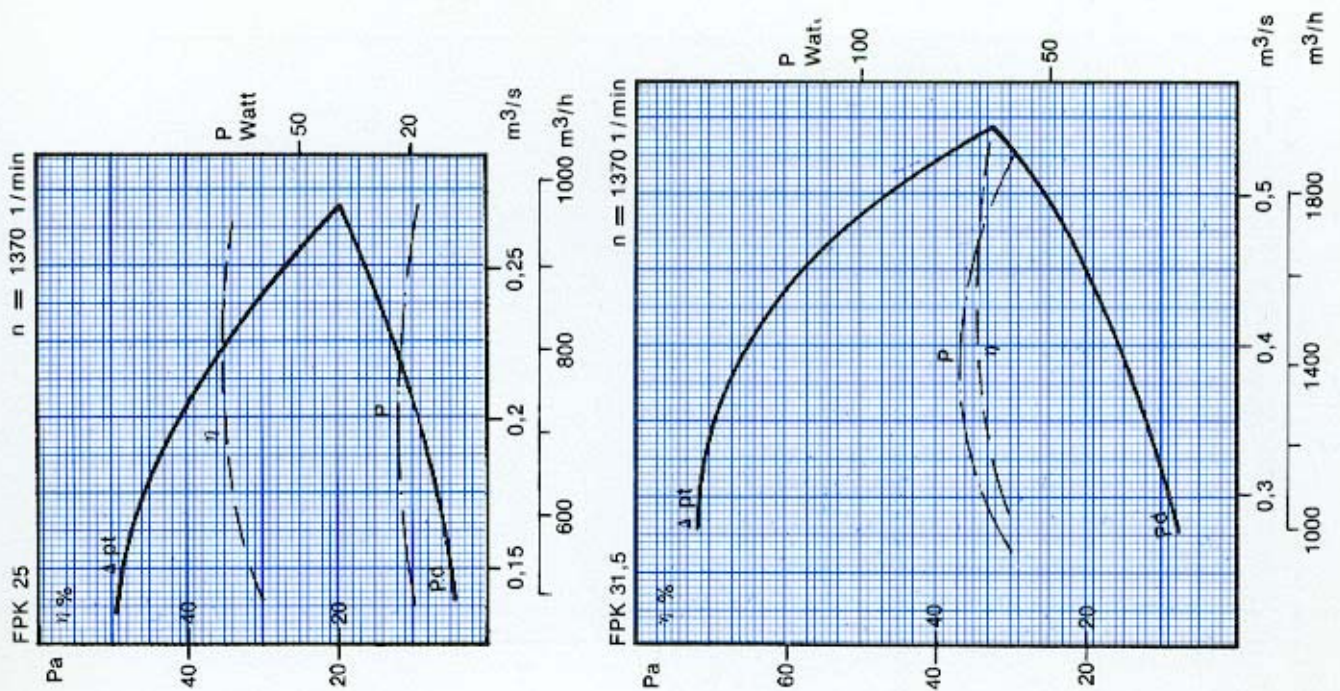
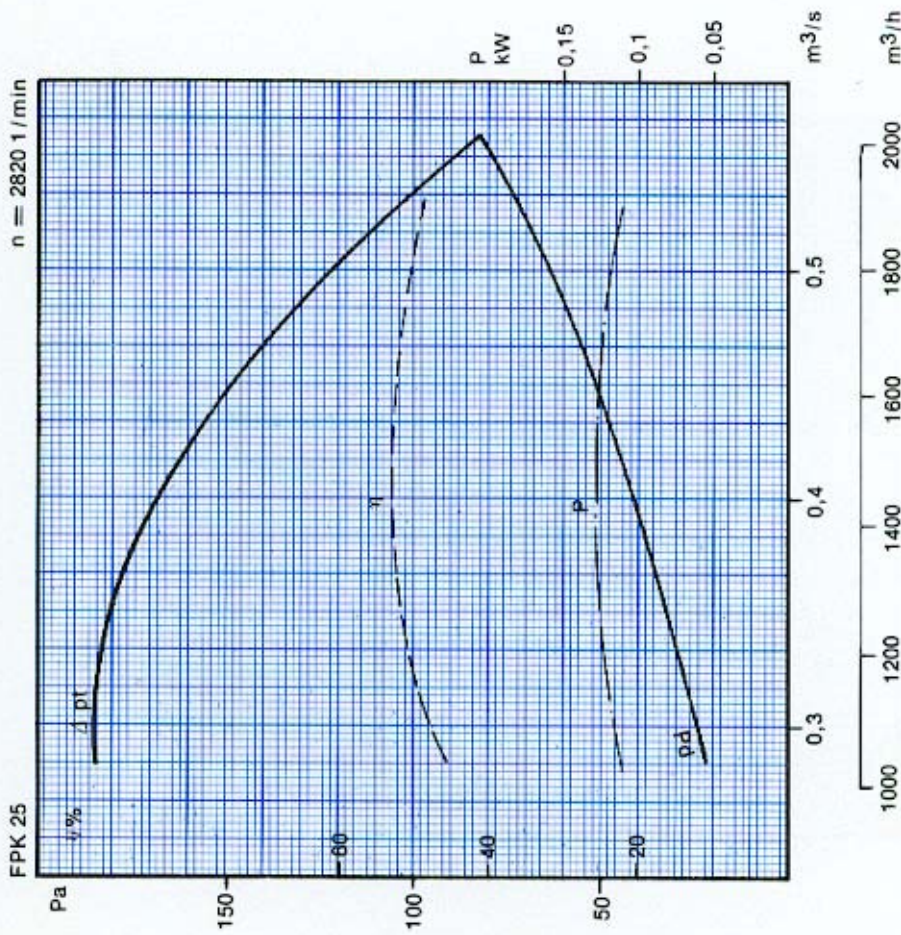



FPK-Ominaiskäyrät

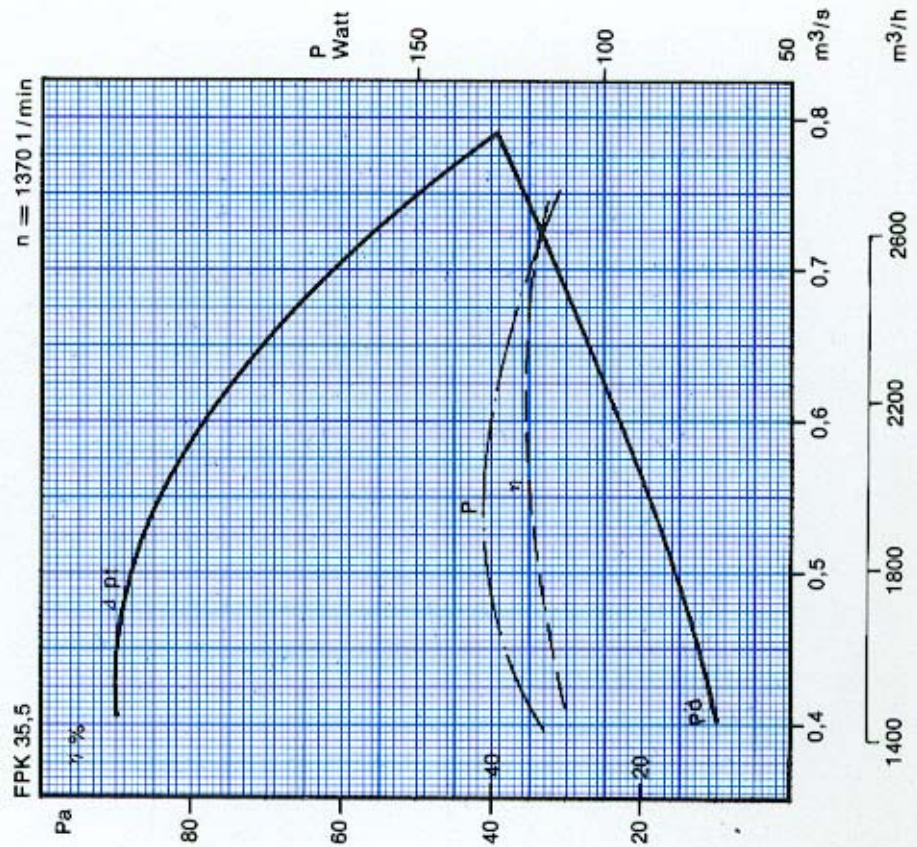
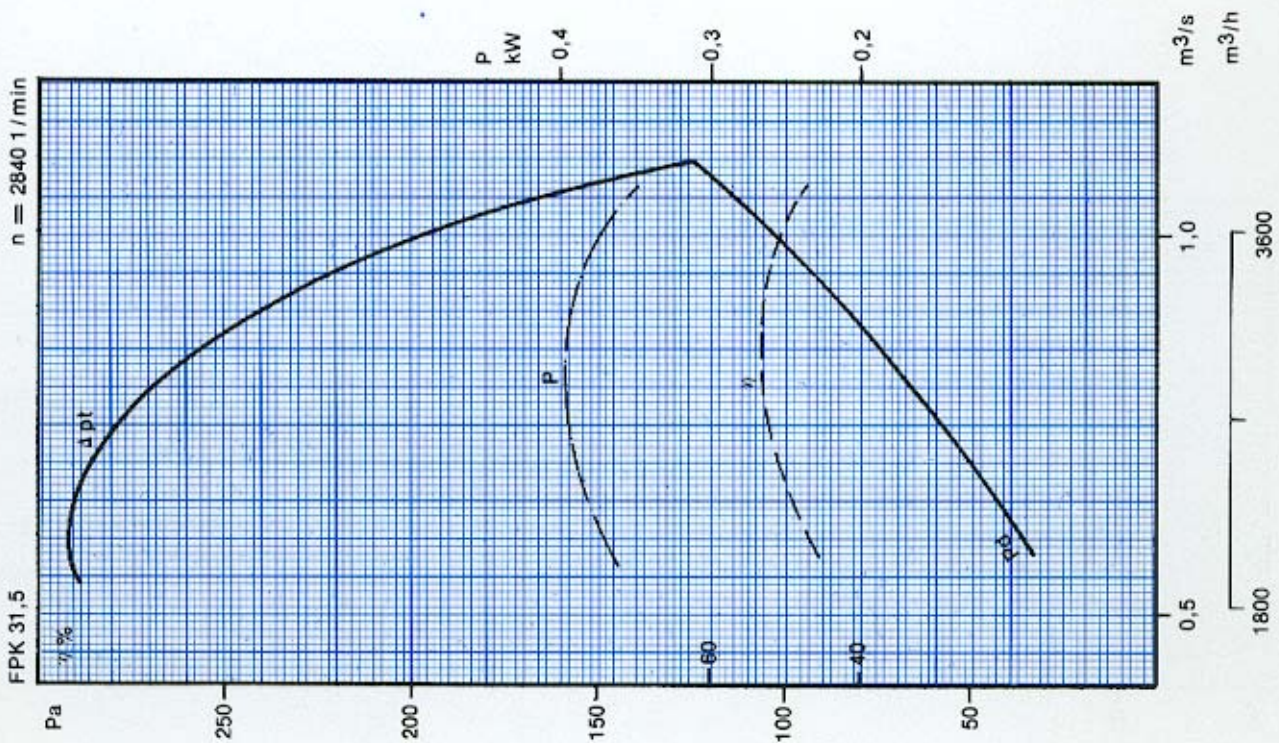



FPK-Ominaiskäyrät

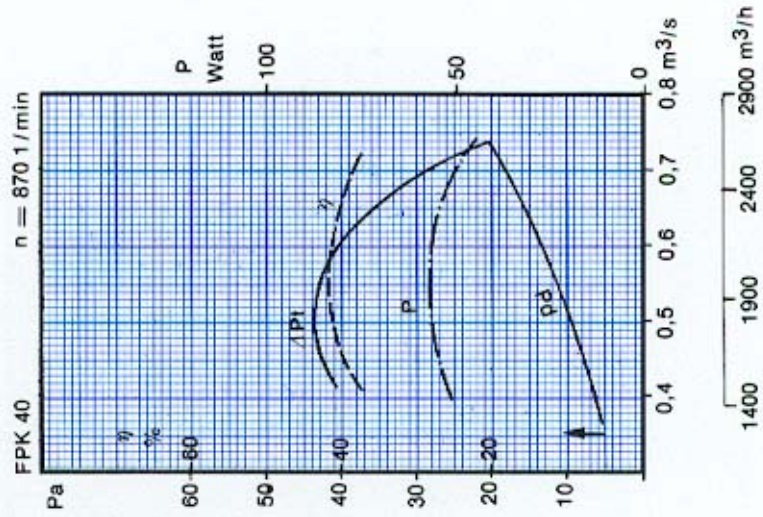
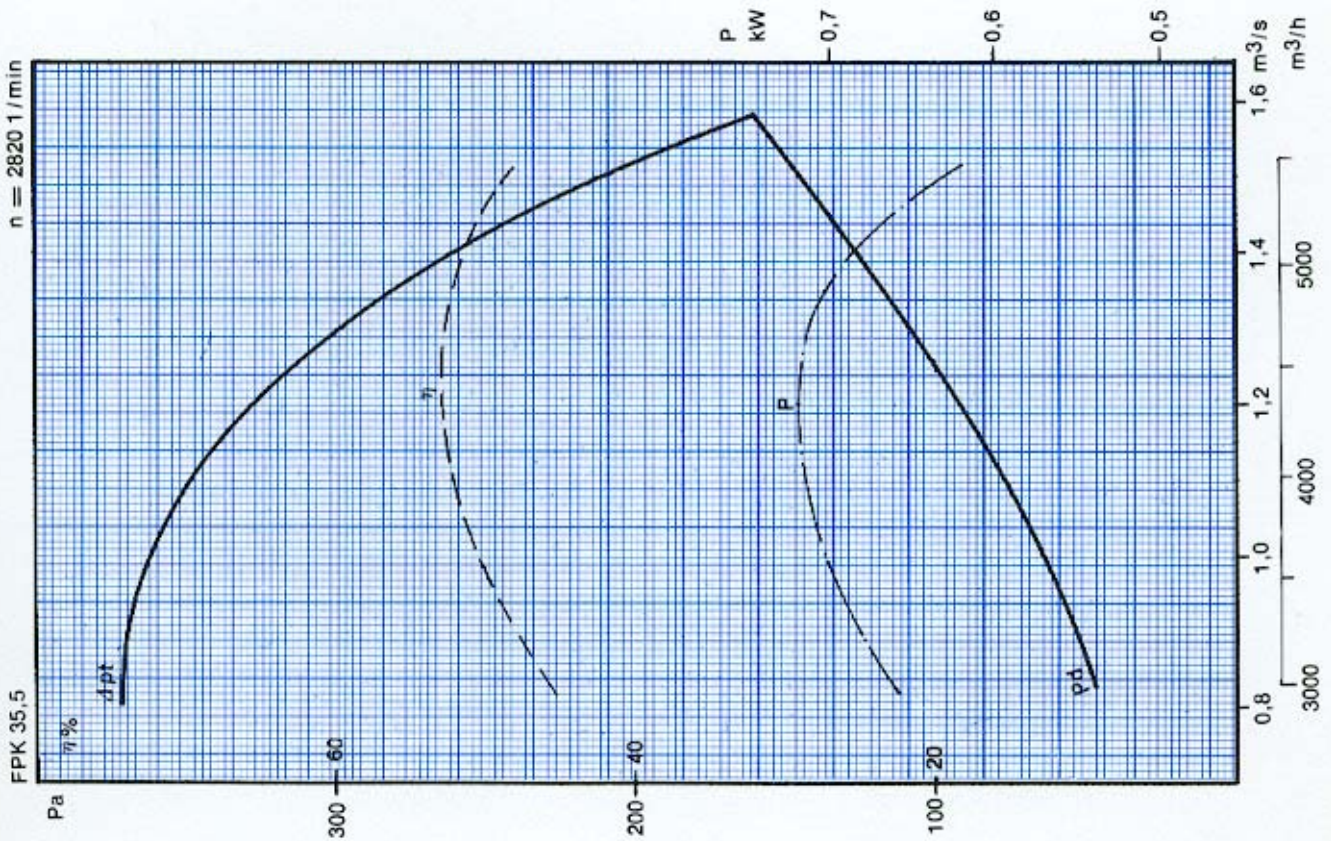



FPK-Ominaiskäyrät

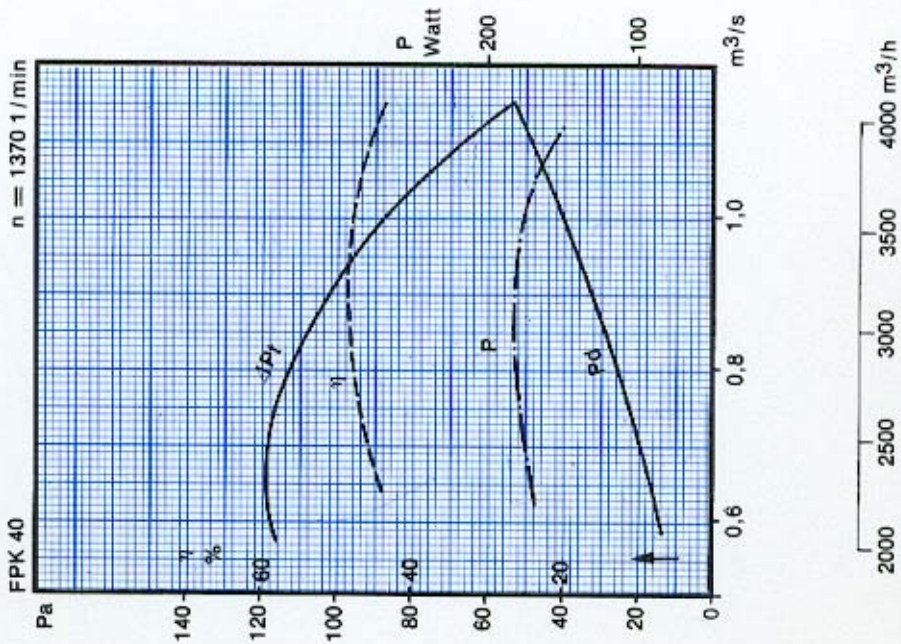
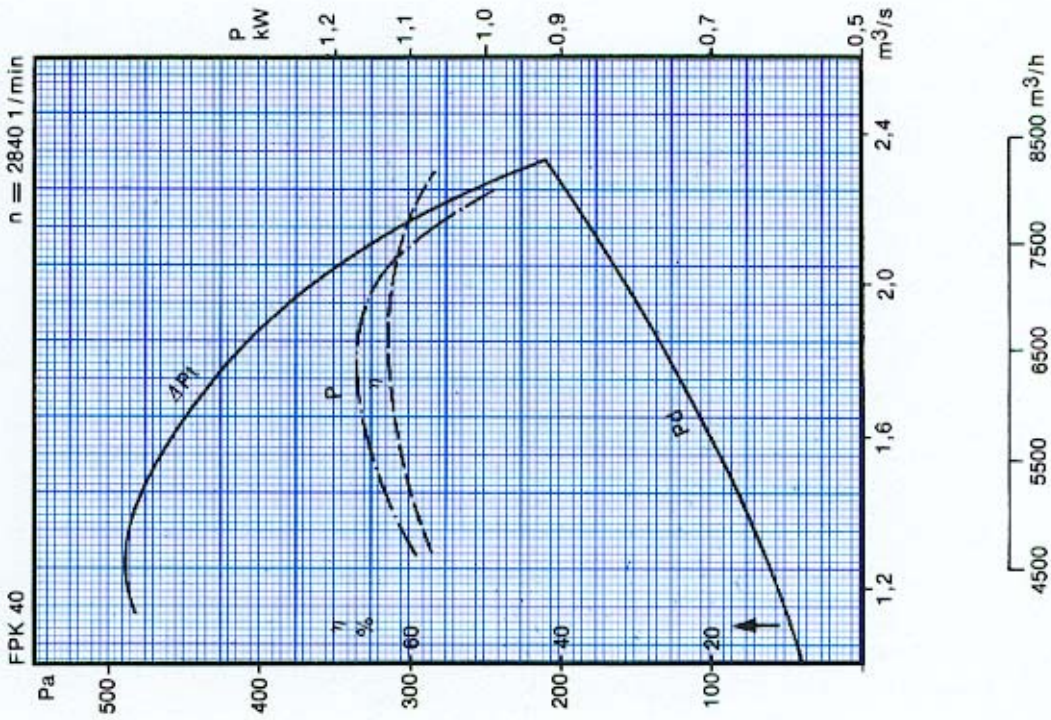



FPK-Ominaiskäyrät

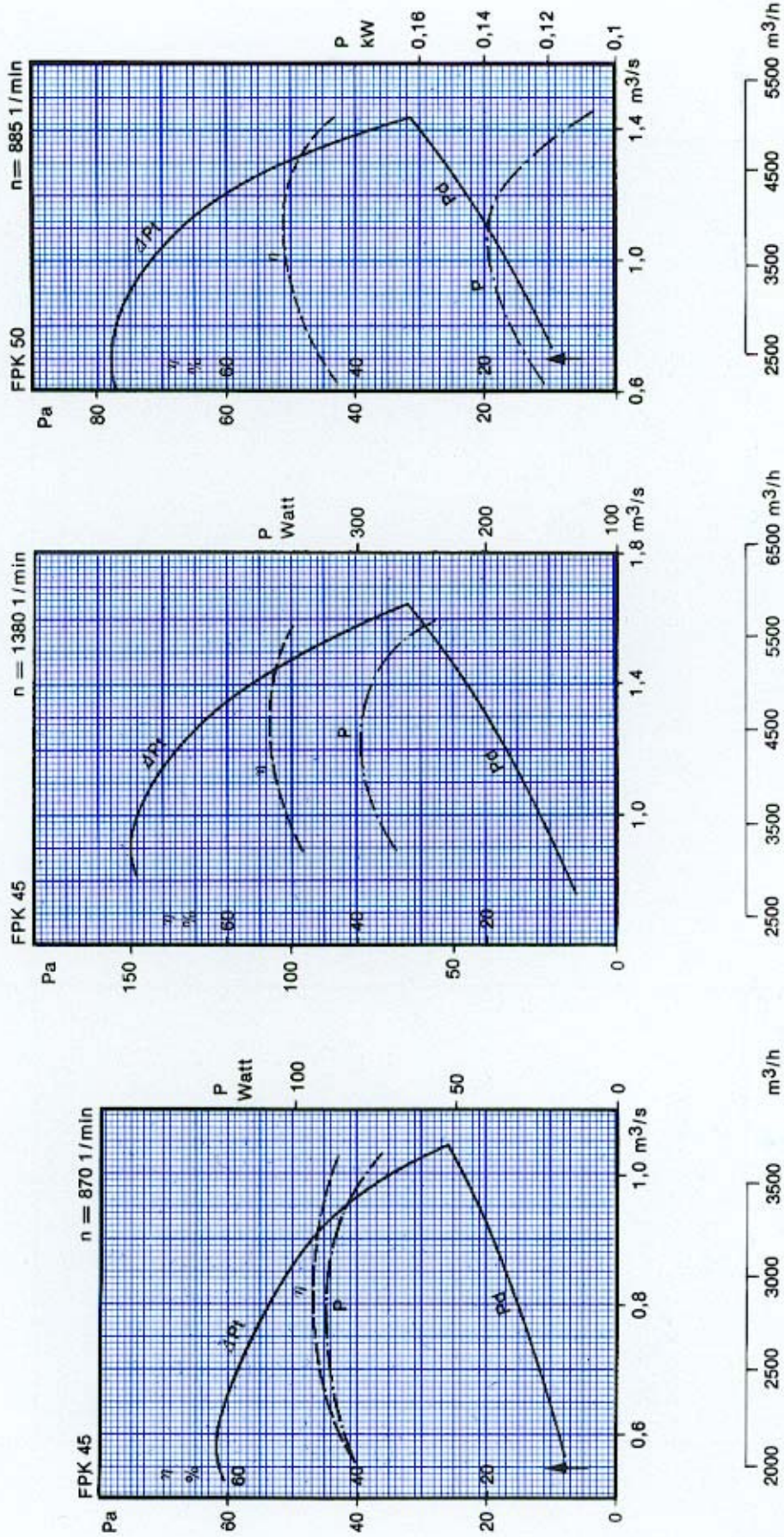



FPK-Ominaiskäyrät

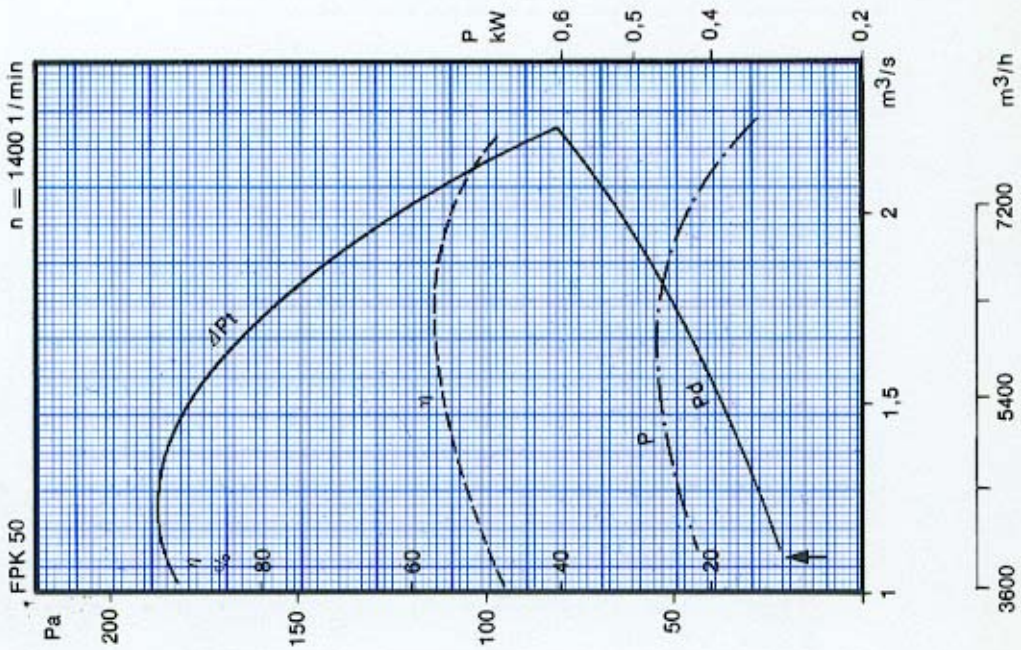
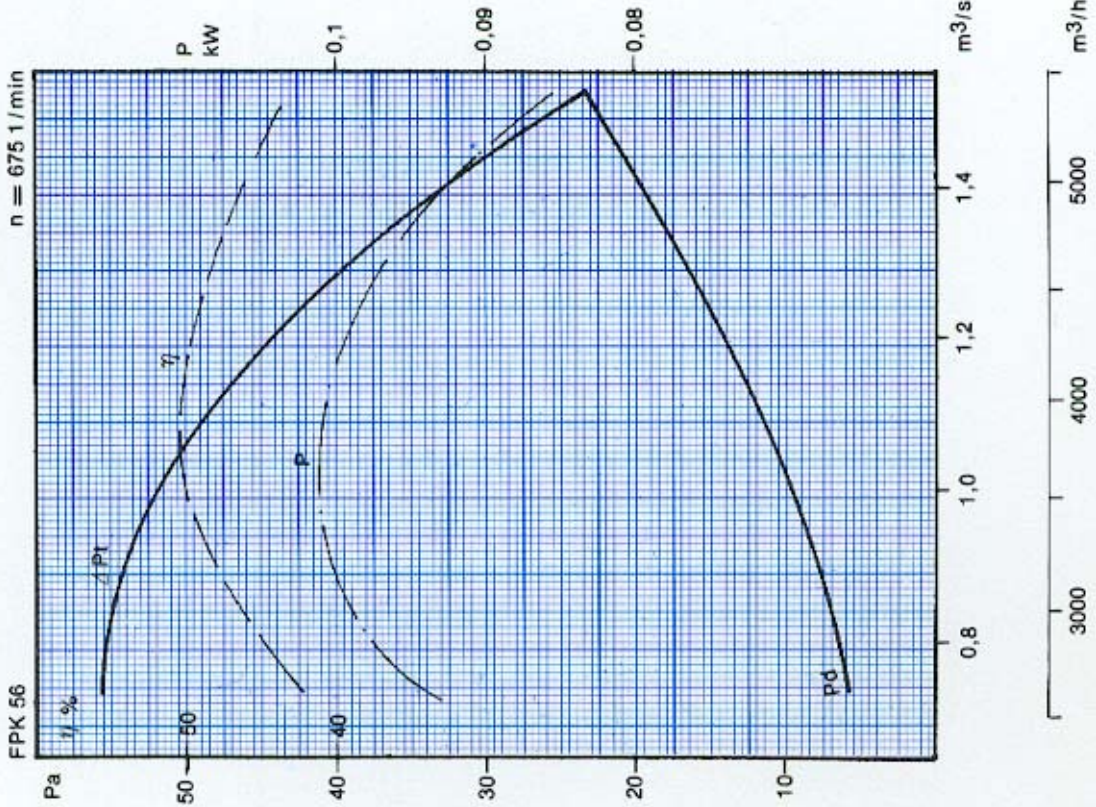



FPK-Ominaiskäyrät

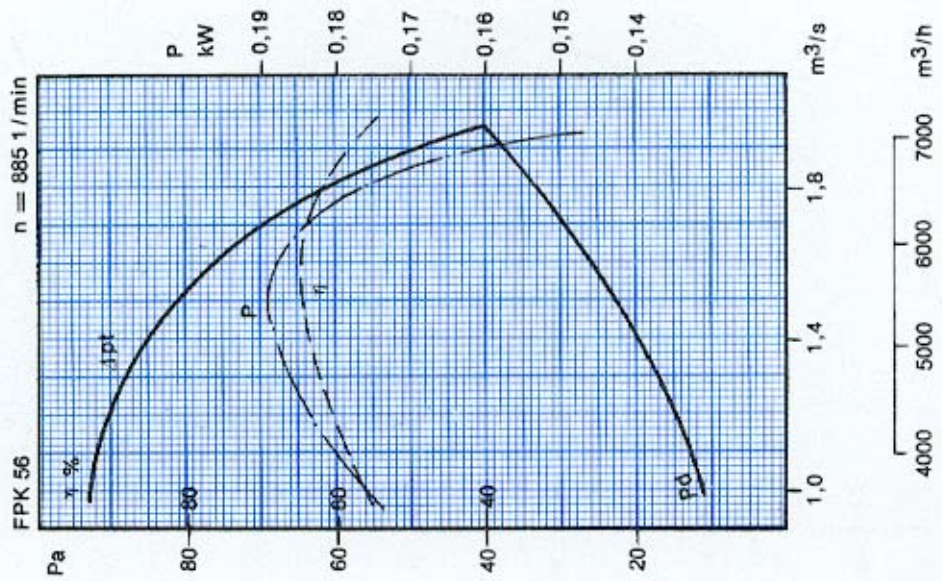
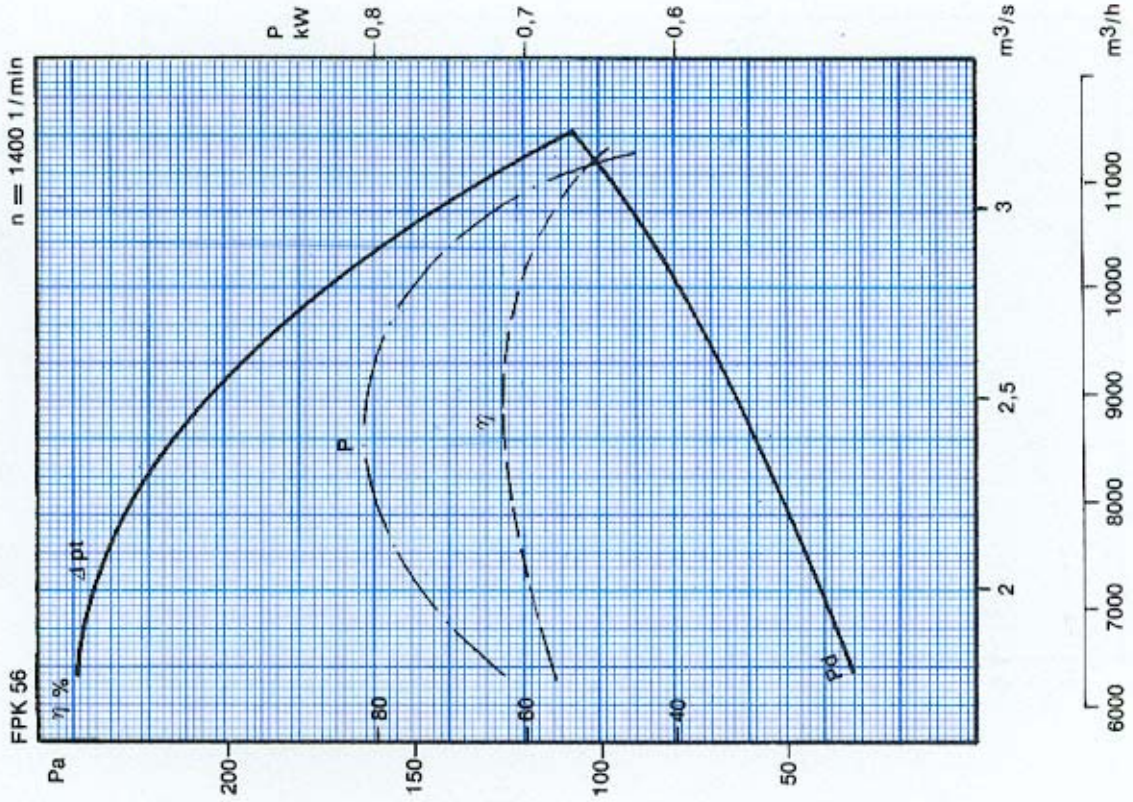



FPK-Ominaiskäyrät

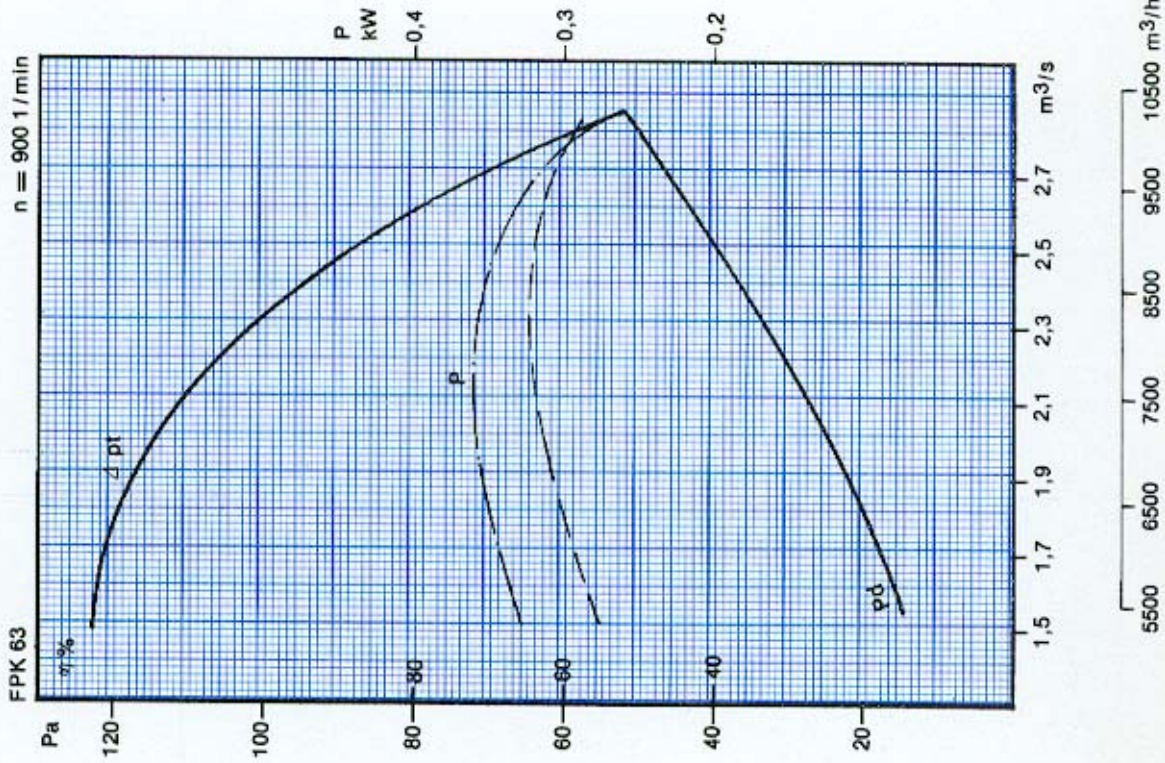
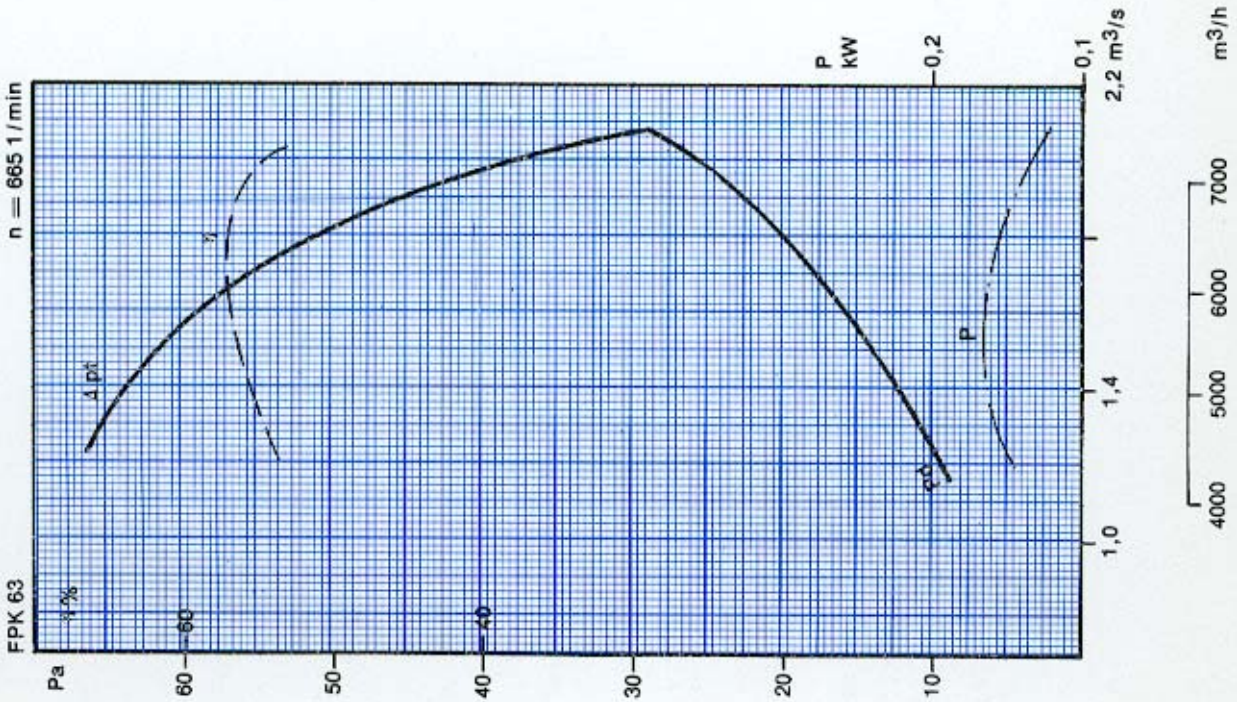



FPK-Ominaiskäyrät

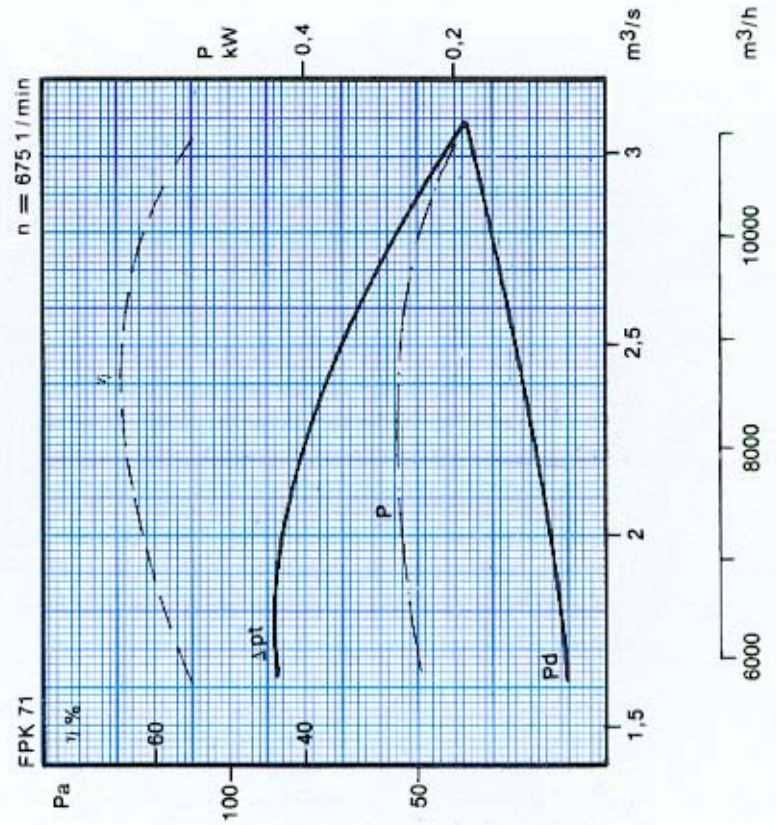
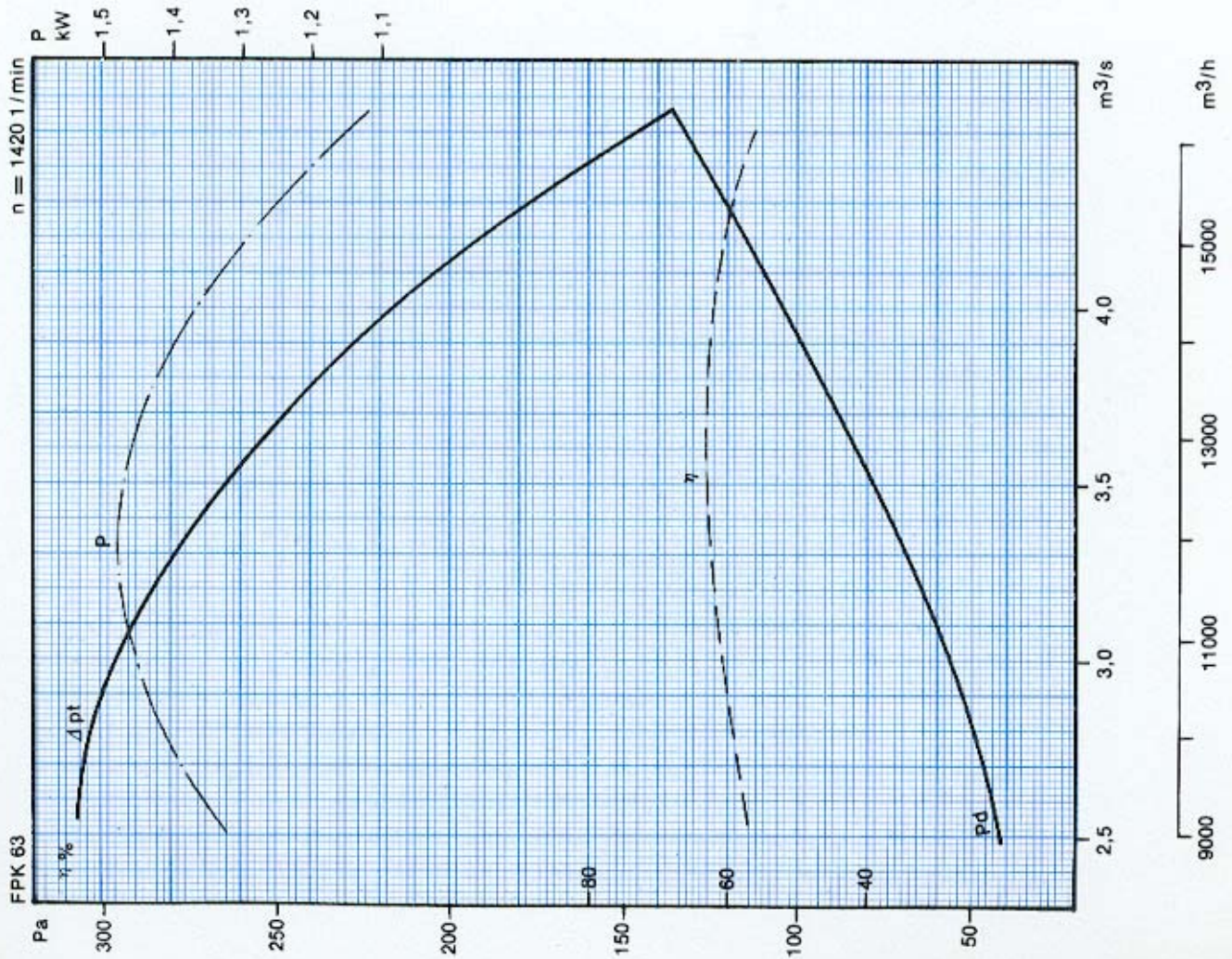



FPK-Ominaiskäyrät

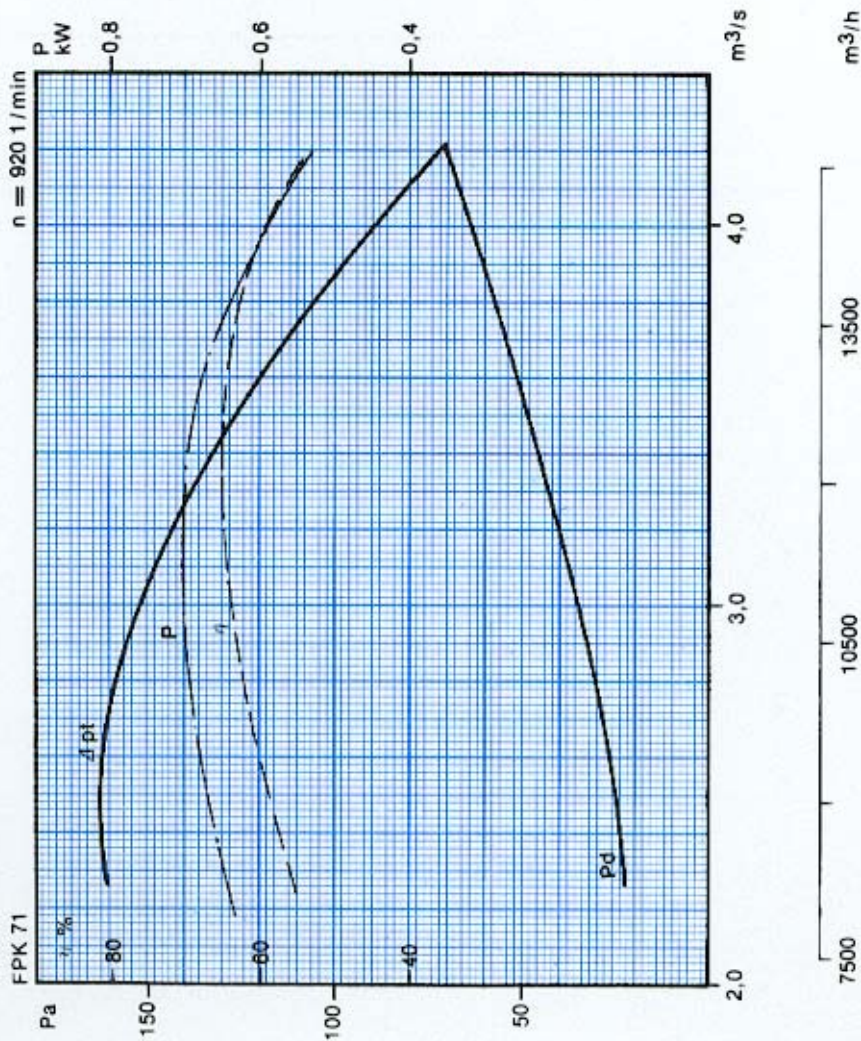
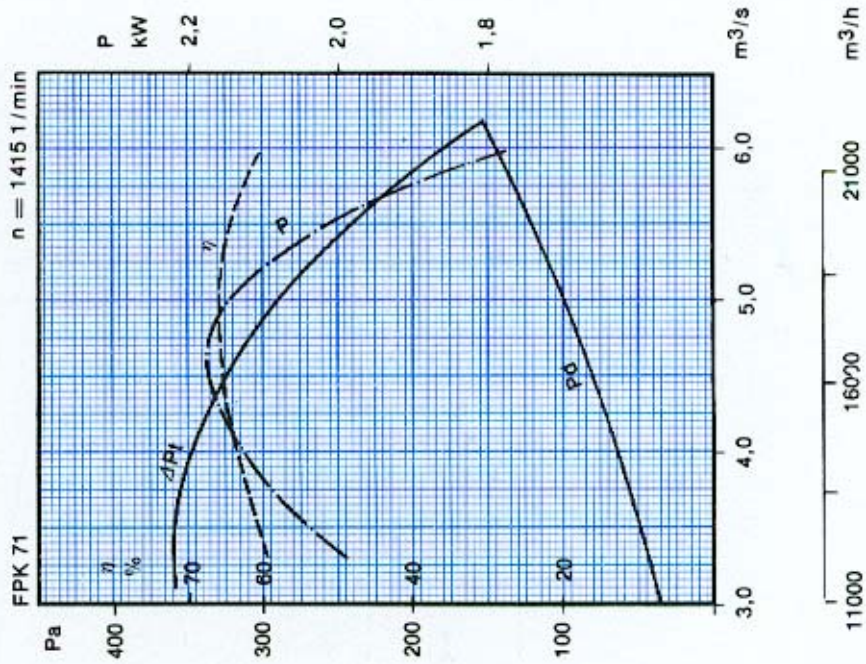



FPK-Ominaiskäyrät

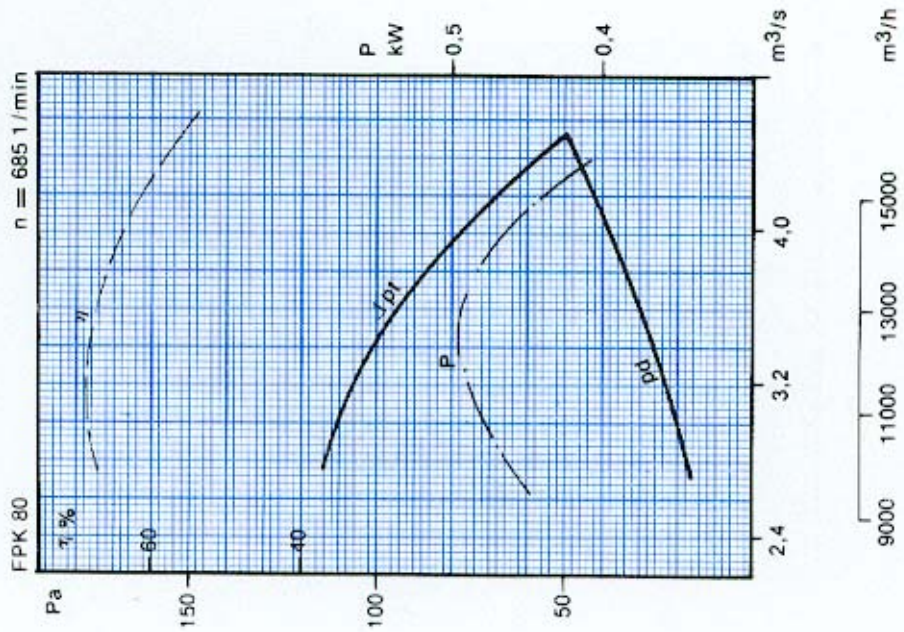
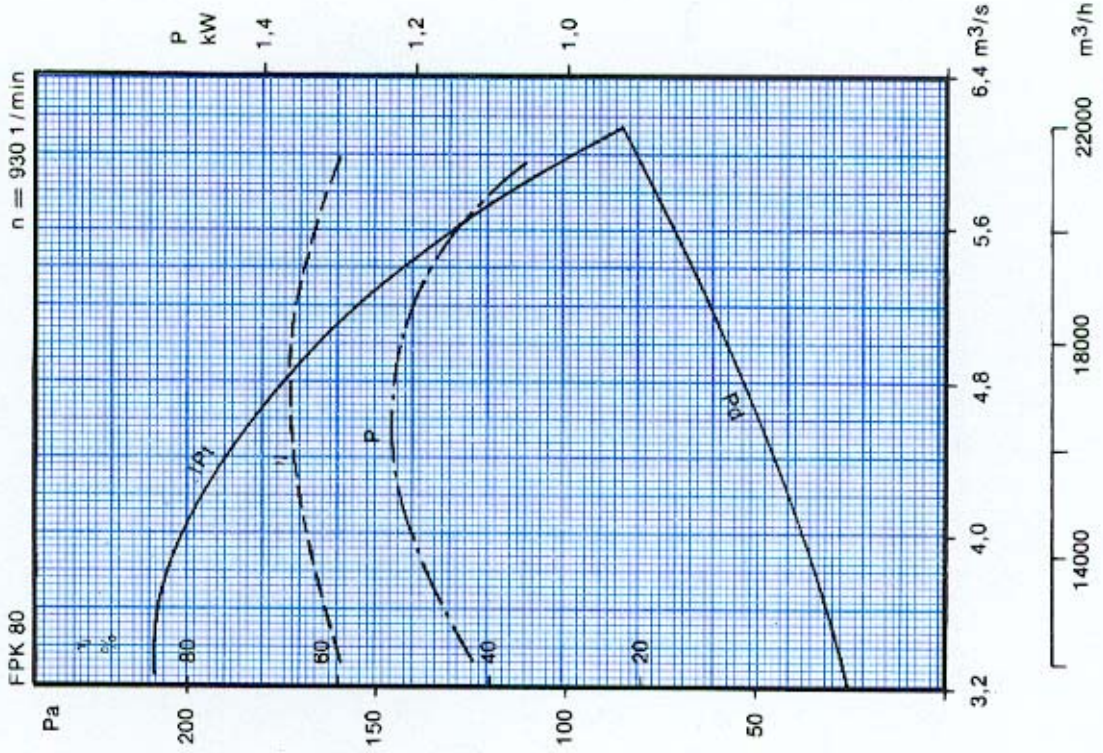



FPK-Ominaiskäyrät

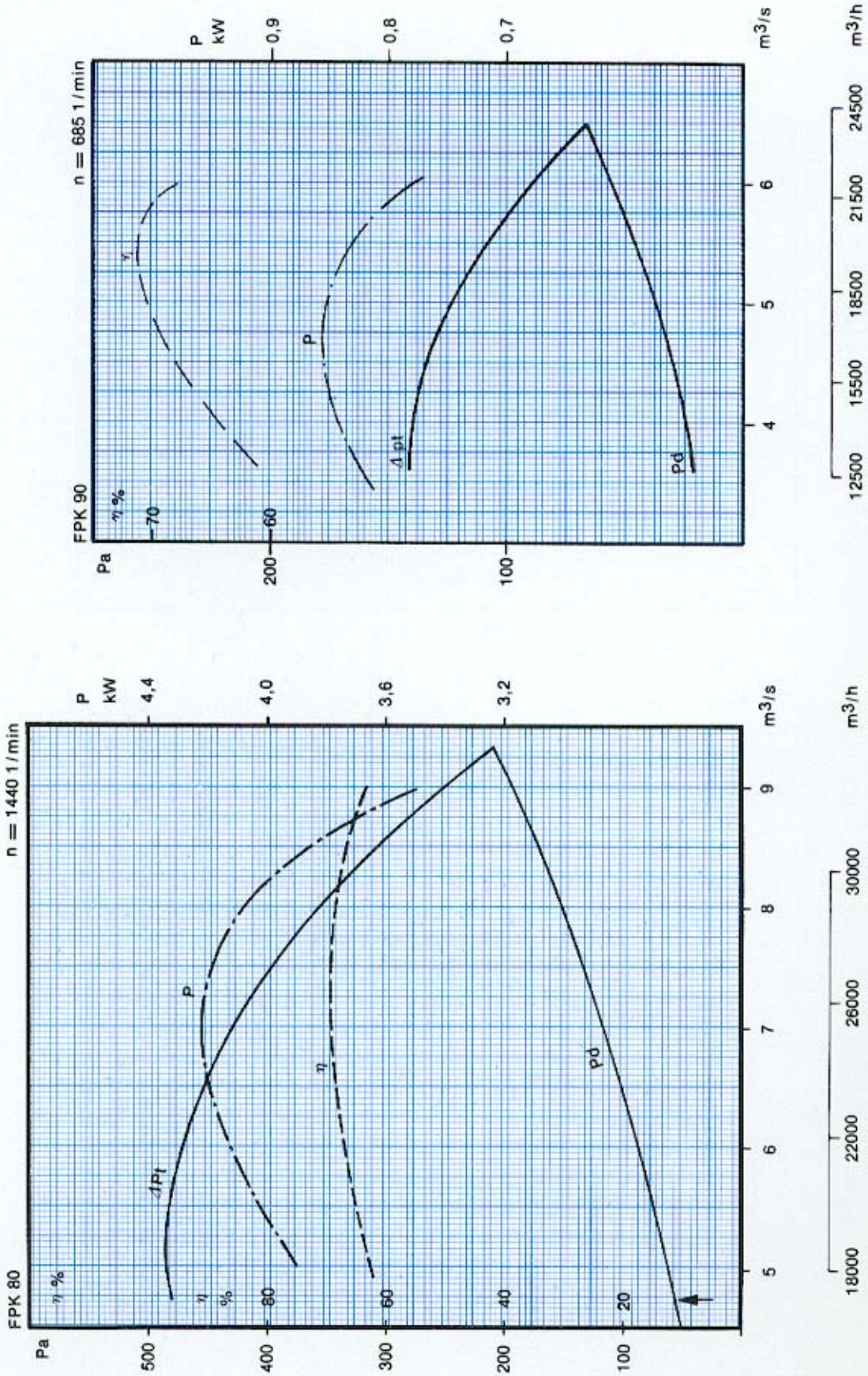



FPK-Ominaiskäyrät

20-15
91-02

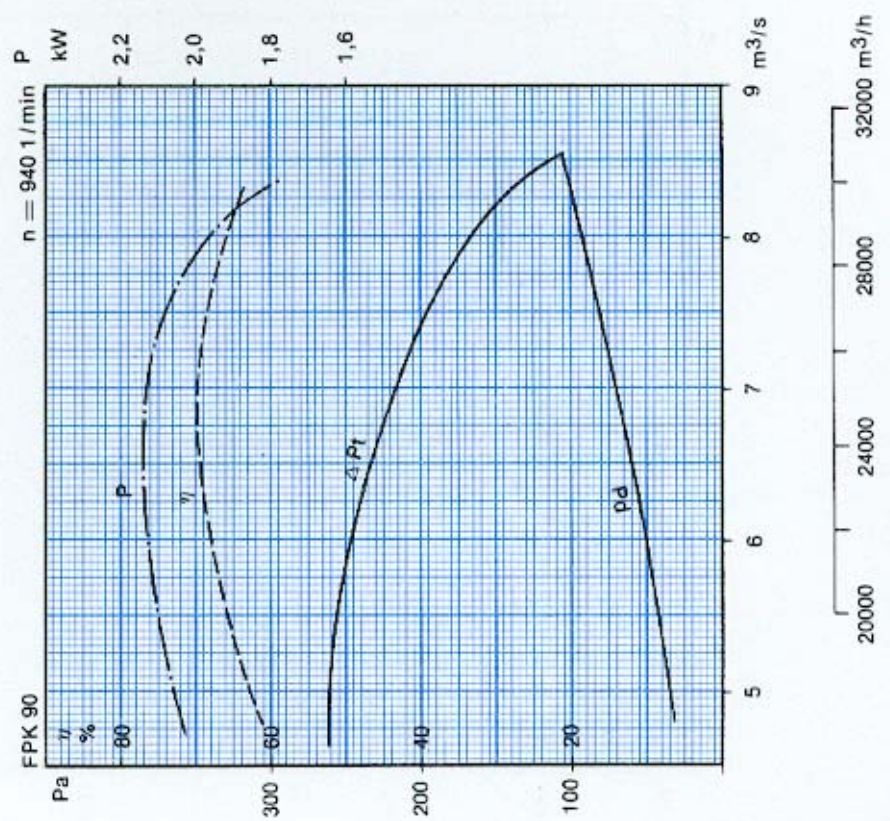
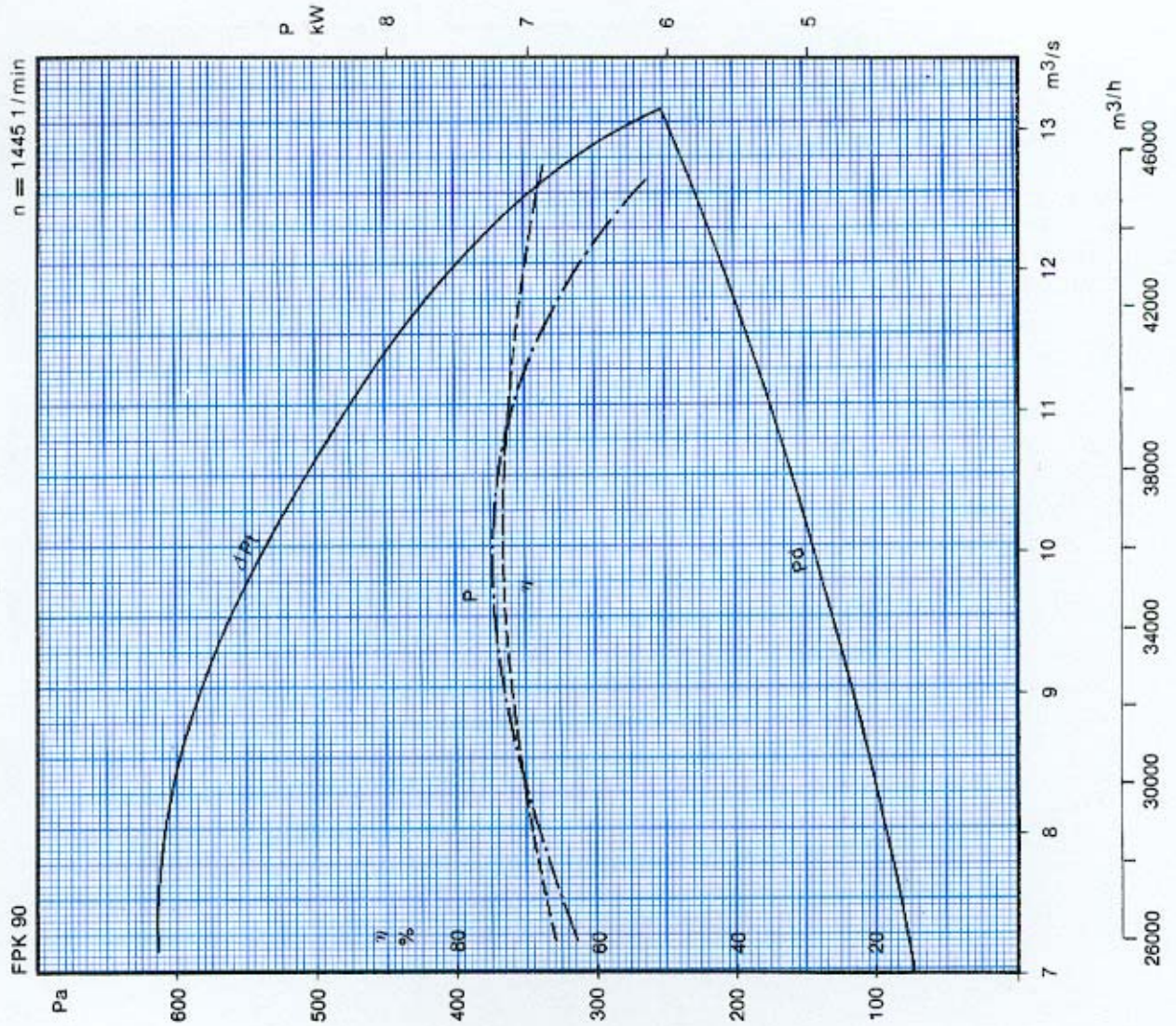



FPK-Ominaiskäyrät

20-16
91-02

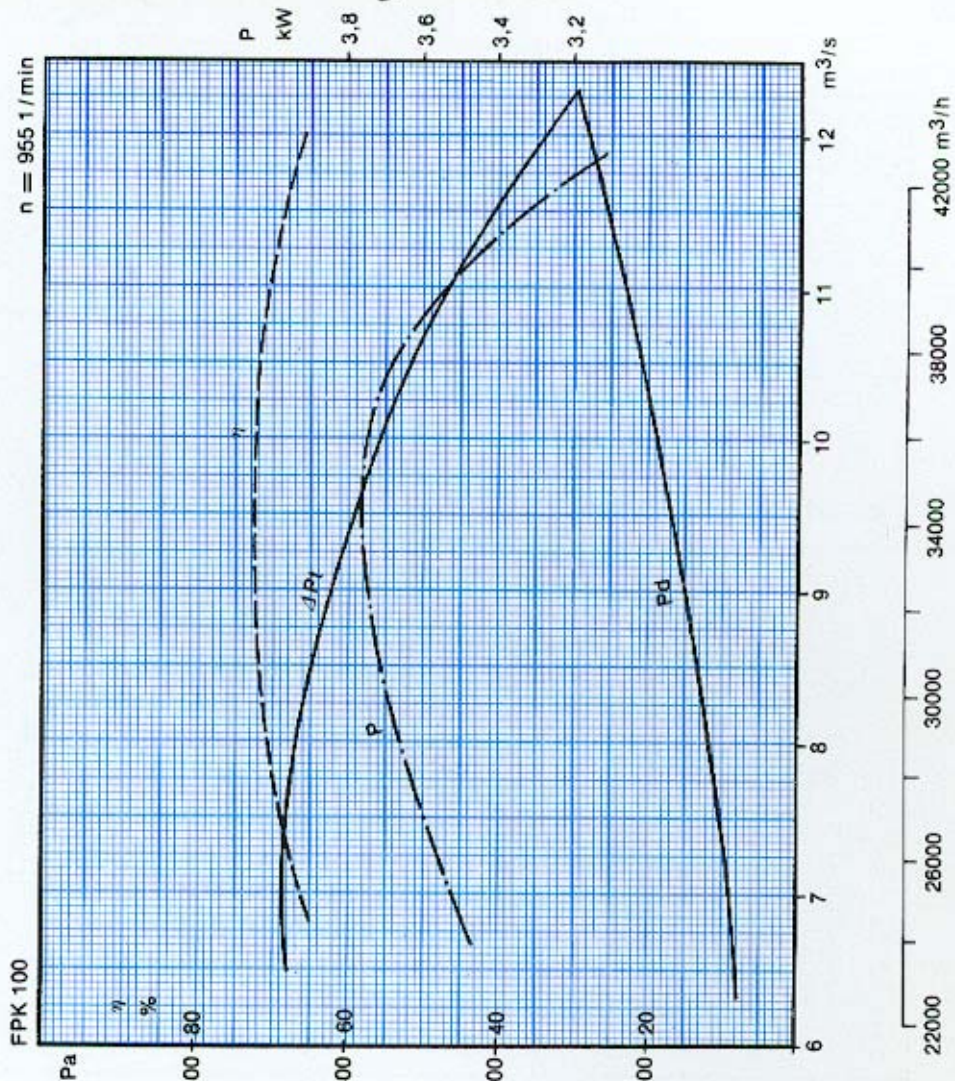
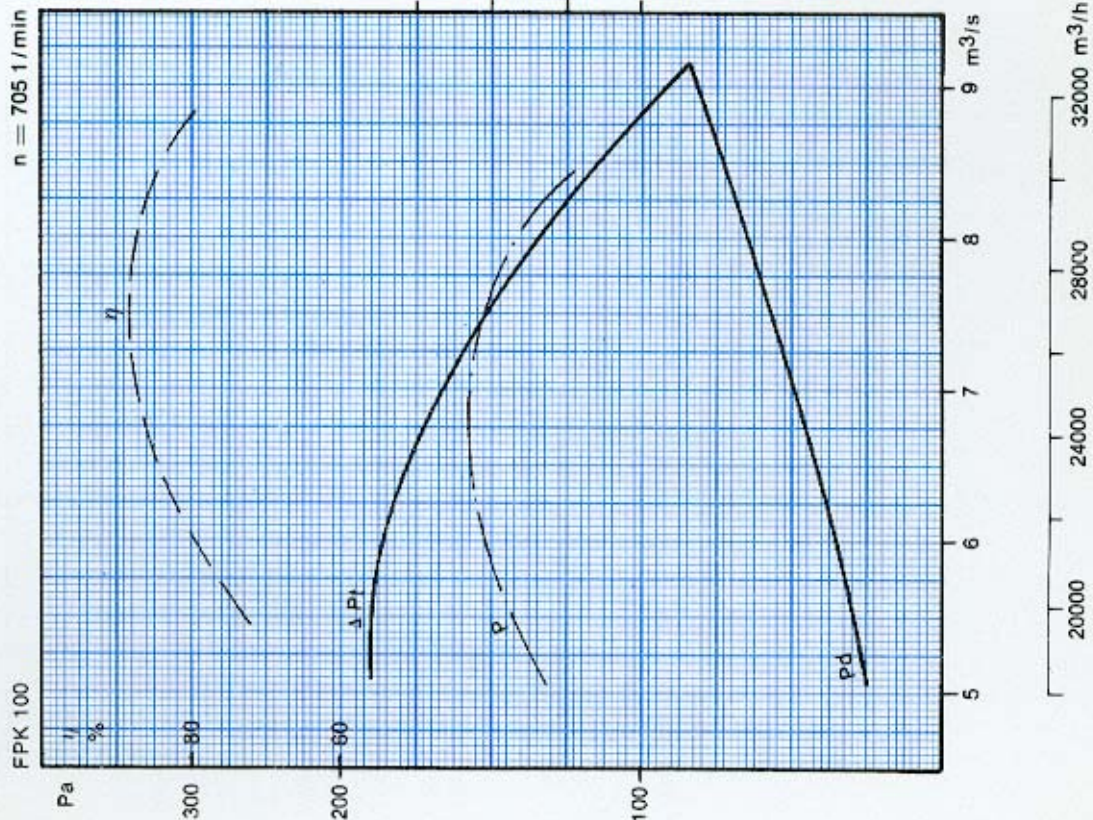



FPK-Ominaiskäyrät

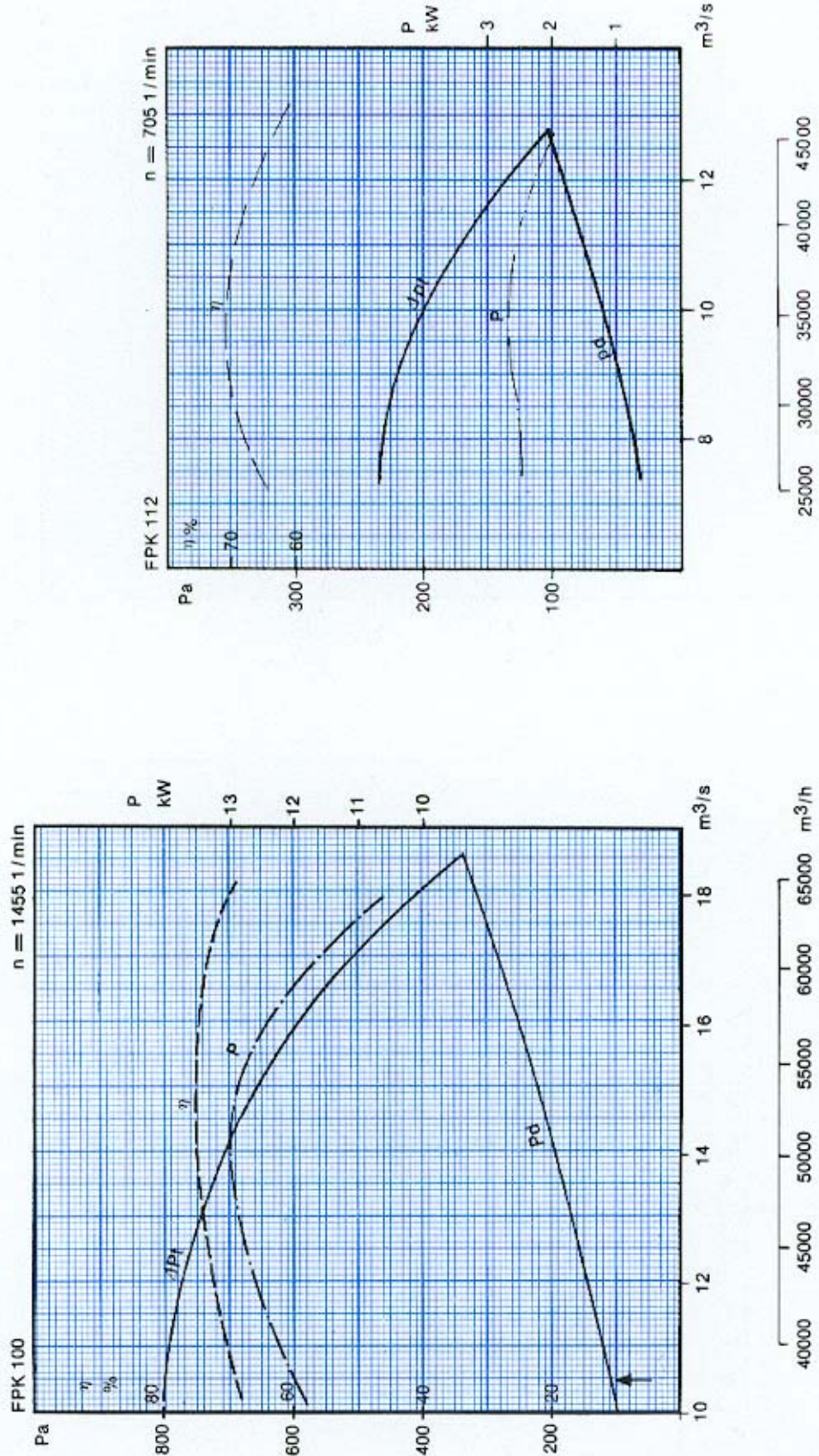



FPK-Ominaiskäyrät

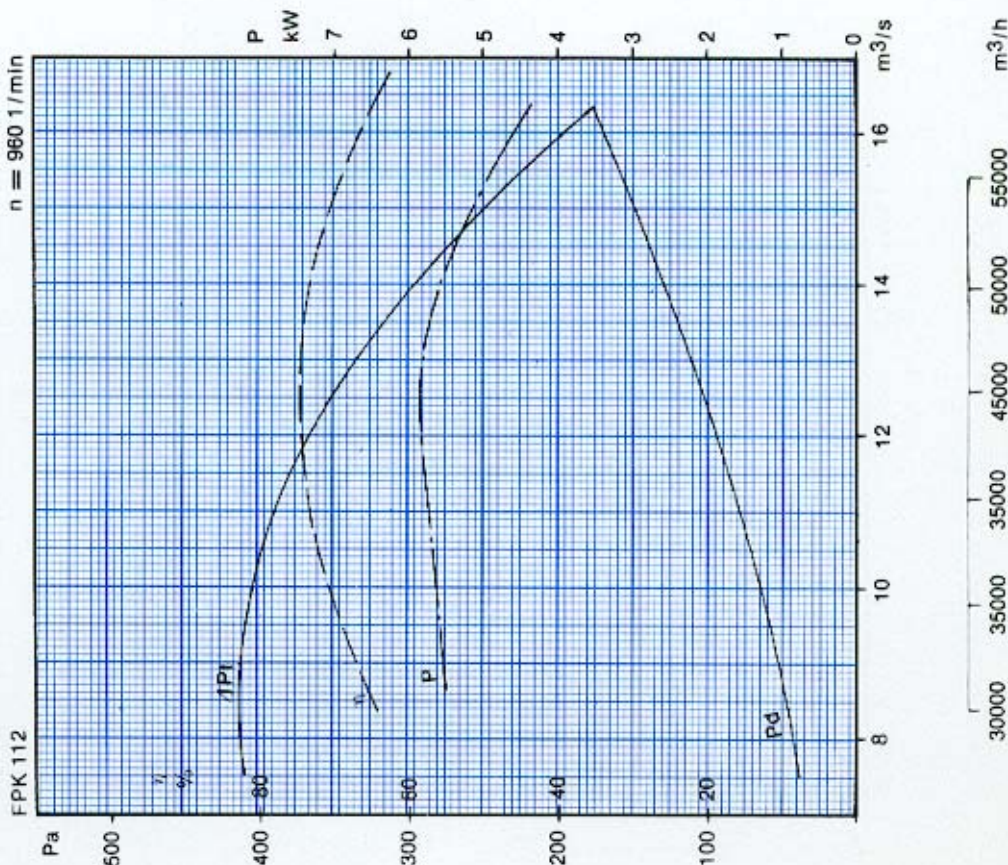
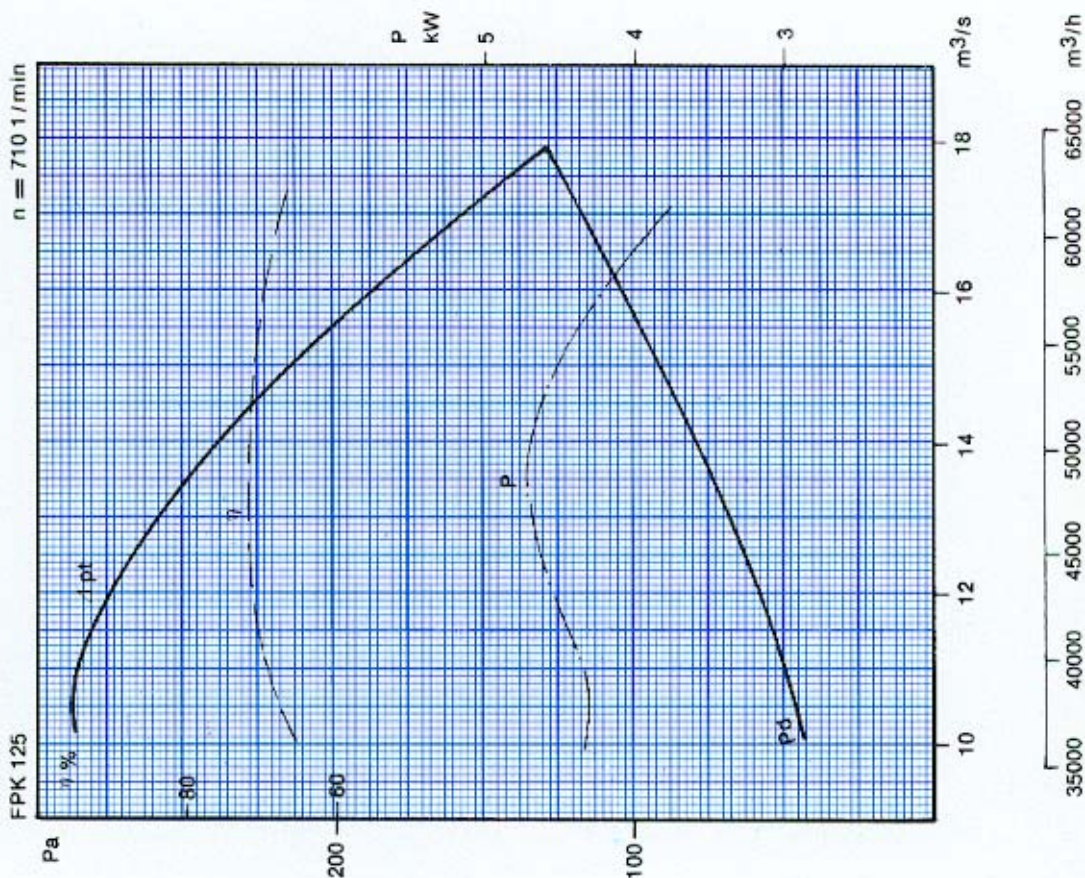



FPK-Ominaiskäyrät

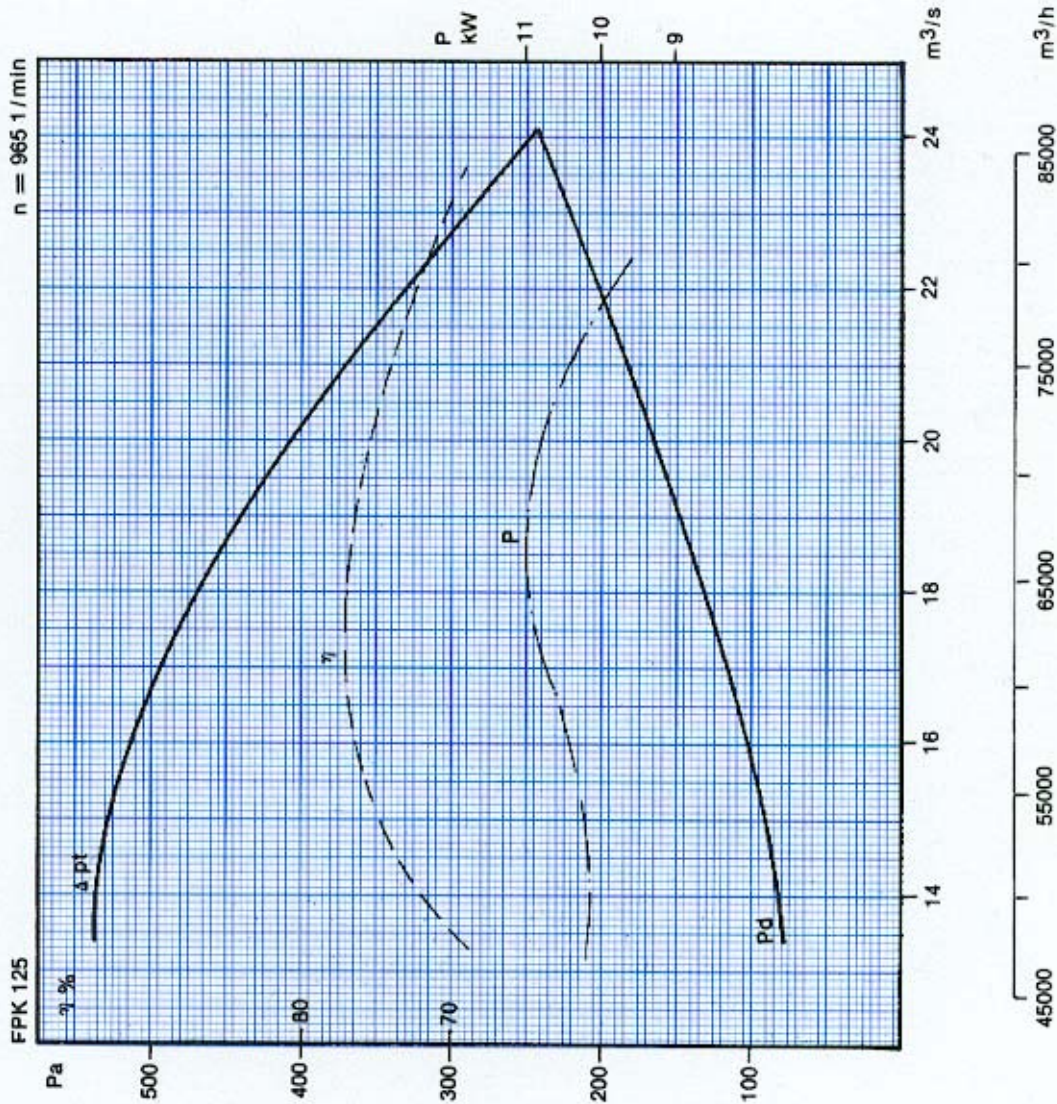



Äänitiedot FPK 1 ja 6 sovitteille

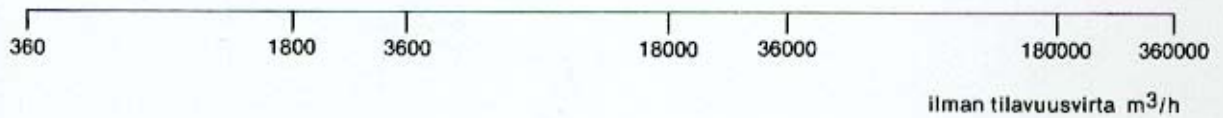
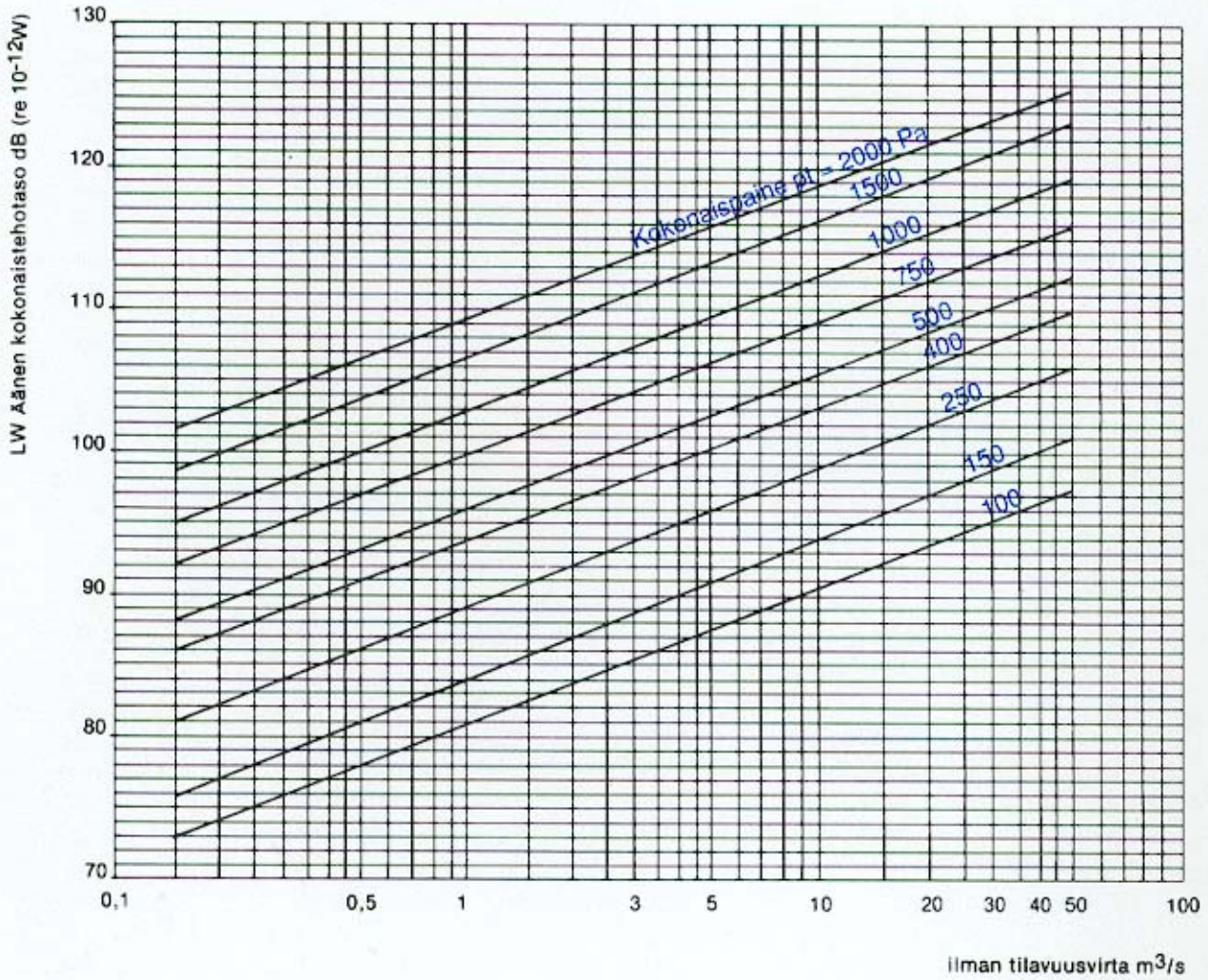

Oktaavikaista Hz	63	125	250	500	1000	2000	4000	8000
Vähentämällä seuraavat korjaustekijät puhaltimen äänen tehotasosta saadaan tehotaso eri oktaavikaistoilla	-7	-9	-7	-7	-10	-14	-18	-23



FPK-1-sovitus

Mittapiirros ja moottoritiedot

20-21
91-02

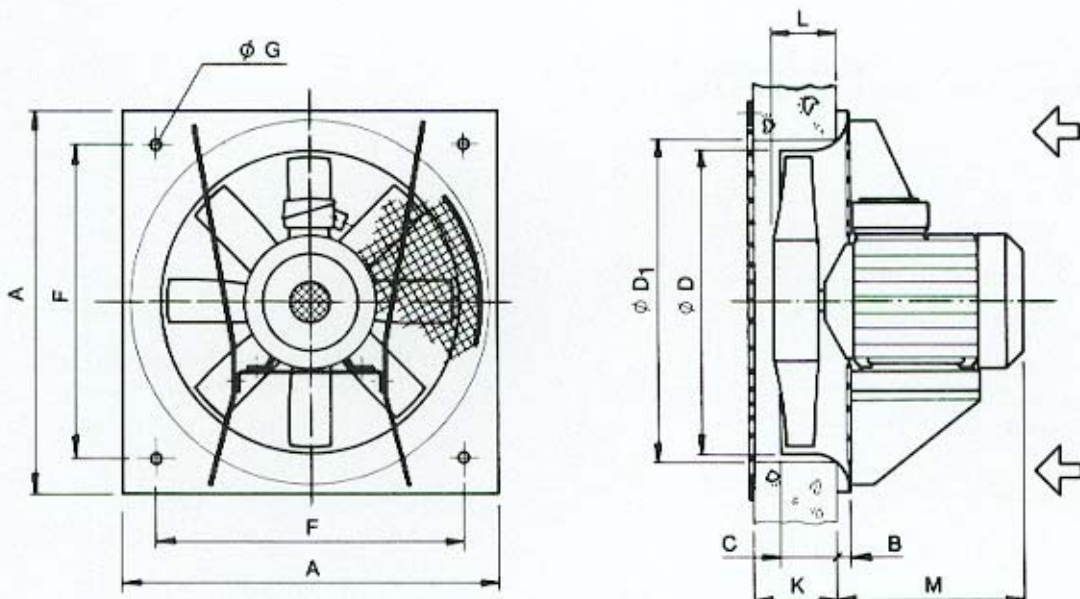

Tilausesimerkki

Akslaalipuhallin FPK — aa — bb — 1 — ...

Koko [25, 31 ...]

Moottori — [7, 9, 14 tai 28]

Sovitus]

Materiaali teräs maalattu]

Voidaan tehdä myös muista materiaaleista.

Mittapiirros

Tyyppi	A	B	C	D1	D	F	G	K	L	M	Paino kg
FPK-25	322	17	31	204	250	262	11,5	60	38	166	4
FPK-31	400	17	42	331	315	328	11,5	73	51	195	6
FPK-35	448	17	52	375	355	368	11,5	83	62	228	8
FPK-40	502	17	58	428	400	402	11,5	93	71	226	9
FPK-45	563	17	65	480	450	463	15	100	83	209	12
FPK-50	624	22	65	538	500	504	15	111	88	224	15
FPK-56	696	22	73	604	560	566	18	128	100	220	21
FPK-63	780	22	88	674	630	628	18	138	119	245	25
FPK-71	877	22	97	766	710	725	18	152	131	285	39
FPK-80	985	22	118	870	800	835	18	177	158	278	46
FPK-90	1106	22	134	972	900	906	22	190	174	274	88
FPK-100	1226	22	150	1086	1000	1002	22	213	198	346	102
FPK-112	1370	22	171	1218	1120	1122	22	245	229	334	132
FPK-125	1526	22	186	1372	1250	1258	22	264	248	406	153

Paino ilman moottoria.

Laippa SFS 4281 mukaan

Moottoriluettelo (yksinopeusmoottorilla)

Moottoritiedot tarkennetaan tilauksen yhteydessä

FPK tyyppi	bb	IEC-tunnus	Teho kw	IN (380 V) A	rimin	Paino kg
25	28	71-14	0,37	1,0	2820	5,5
	14	71-14	0,25	0,85	1400	5,5
31	28	71-14	0,55	1,5	2790	6,2
	14	71-14	0,25	0,85	1400	5,5
35	9	71-14	0,18	0,75	920	5,5
	14	71-14	0,25	0,85	1400	5,5
40	9	71-14	0,18	0,75	920	5,5
	14	71-14	0,25	0,85	1400	5,5
45	9	71-14	0,37	1,15	1400	6,5
	9	71-14	0,18	0,75	920	5,5
50	14	80-19	0,55	1,55	1410	9,0
	9	71-14	0,18	0,75	920	5,5
56	14	80-19	1,1	2,9	1410	13,0
	9	71-14	0,25	1,05	885	7,2
63	7	80-19	0,13	0,7	700	8,5
	14	80L24	1,5	3,7	1420	16,0
71	9	80-19	0,37	1,25	920	8,5
	7	80-19	0,18	0,9	700	9,5
80	14	100L28	2,2	5,2	1430	20,5
	9	80S24	0,75	2,4	920	12,5
80	7	80S24	0,37	1,55	700	12,5
	14	132S38	5,5	12,0	1425	40,0
90	9	100L28	1,5	4,2	950	23,0
	7	90L24	0,55	2,1	680	15,0
90	14	132M38	7,5	16,0	1430	50,0
	9	112M28	2,2	5,6	930	31,0
100	7	100L28	1,1	3,6	700	22,5
	14	180L42	15,0	31,0	1450	91,0
100	9	132M38	4,0	9,0	940	50,0
	7	132S38	2,2	6,6	700	40,0
112	9	180M42	7,5	17,0	960	75,0
	7	132M38	3,0	9,0	700	52,0
125	9	180L48	15,0	31,0	960	132,0
	7	180M42	5,5	12,5	710	77,0

FPK-1-sovitetta toimitetaan myös kaksinopeusmoottorilla.



FPK-6-sovitus

Mittapiirros ja moottoritiedot

20-22
91-02

Rakenne

FPK-6-sovite toimitetaan normaalisti maalattusta teräksestä. Potkuri on korroosion kestävää alumiinivalua. Se on tasapainotettu dynaamisesti.

Tilaukesimerkki

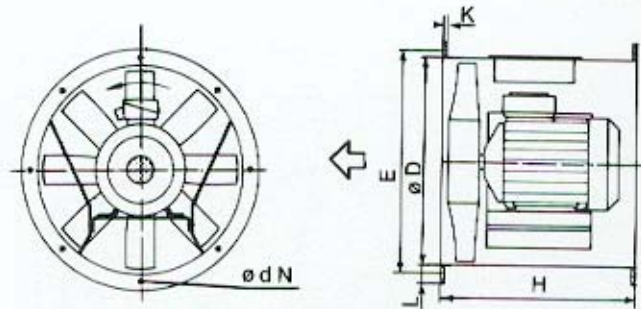

Moottoriluettelo (yksinopeusmoottorit)

Moottoritiedot tarkennetaan tilauksen yhteydessä

FPK tyyppi	bb	IEC-tunnus	Teho kW	IN (380 V) A	rimin	Paino kg
25	28	71-14	0,37	1,0	2820	5,5
	14	71-14	0,25	0,85	1400	5,5
31	28	71-14	0,55	1,5	2790	6,2
	14	71-14	0,25	0,85	1400	5,5
35	9	71-14	0,18	0,75	920	5,5
	14	71-14	0,25	0,85	1400	5,5
40	9	71-14	0,18	0,75	920	5,5
	14	71-14	0,25	0,85	1400	5,5
45	14	71-14	0,37	1,15	1400	6,5
	9	71-14	0,18	0,75	920	5,5
50	14	80-19	0,55	1,55	1410	9,0
	9	71-14	0,18	0,75	920	5,5
56	14	80-19	1,1	2,9	1410	13,0
	9	71-14	0,25	1,05	885	7,2
63	7	80-19	0,13	0,7	700	8,5
	14	90L24	1,5	3,7	1420	15,0
	9	80-19	0,37	1,25	920	8,5
	7	80-19	0,18	0,9	700	9,5
71	14	100L28	2,2	5,2	1430	20,5
	9	90S24	0,75	2,4	920	12,5
80	7	90S24	0,37	1,55	700	12,5
	14	132S38	5,5	12,0	1425	40,0
90	9	100L28	1,5	4,2	950	23,0
	7	90L24	0,55	2,1	680	16,0
100	14	132M38	7,5	16,0	1430	50,0
	9	112M28	2,2	5,6	930	31,0
	7	100L28	1,1	3,6	700	22,5
112	14	160L42	15,0	31,0	1450	91,0
	9	132M38	4,0	9,0	940	50,0
125	7	132S38	2,2	5,6	700	40,0
	9	160M42	7,5	17,0	960	75,0
125	7	132M38	3,0	9,0	700	52,0
	9	180L48	15,0	31,0	960	132,0
	7	160M42	5,5	12,5	710	77,0

FPK-6-sovitetta toimitetaan myös kaksinopeusmoottorilla.

Mittapiirros

Tyyppi	ø D	E	H	K	L	ø d	N	Paino kg
FPK-25	254	280	270	6	30	10	4	8
FPK-31	319	355	305	6	30	10	8	10
FPK-35	359	395	335	6	30	10	8	11
FPK-40	404	450	345	6	40	12	8	12
FPK-45	454	500	355	6	40	12	8	17
FPK-50	504	560	445	8	50	12	12	20
FPK-56	564	620	476	8	50	12	12	24
FPK-63	636	690	625	8	50	12	12	32
FPK-71	716	770	485	8	50	12	16	44
FPK-80	806	860	530	8	50	12	16	50
FPK-90	906	970	586	10	60	15	16	86
FPK-100	1008	1070	754	10	60	15	16	122
FPK-112	1128	1190	787	10	60	15	20	160
FPK-125	1258	1320	847	10	60	15	20	195

Paino ilman moottoria.

Laippe SFS 4281 mukaan

Lisätarvikkeet

1. Kangasliitin (muovinen)
2. Kangasliitin (raskas rakenne)
3. Tärinänvaimennin
4. Kannatintuki
5. Suojaverkko
6. Vastalaippa

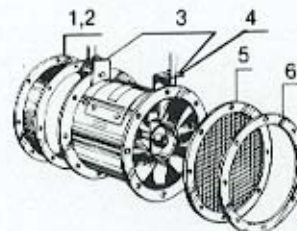

KOJA

VALMISTAJA:

Koja Oy
PL 351, 33101 TAMPERE
Puh. (931) 652 511

MYYNTI:

Koja Oy
PL 351
33101 TAMPERE
Puh. (931) 652 330
Telefax (931) 652 723

Koja Oy
Ohrauhdantie 2 A
00680 HELSINKI
Puh. (90) 752 2055
Telefax (90) 728 7758

Koja Oy
Kajaaninkatu 28 B 16
90100 Oulu
Puh. (981) 229 444
Telefax (981) 229 459