

RYHMÄ- KESKUS

230-1-50
F/10A

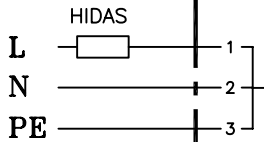

PUHALLINKONVEKTORI SIGMA ___ SH

230-1-50

max _____ kW
max _____ A

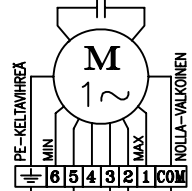

PUHALLINMOOTTORI:
6-NOPEUSKINEN

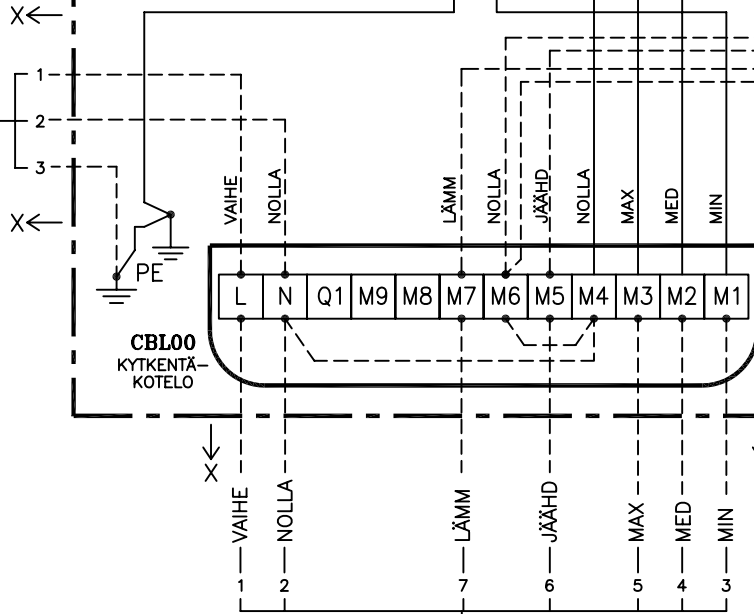

CBLOO
KYTKENTÄ-
KOTELO

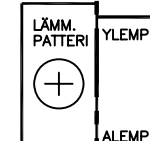
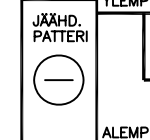

KONDENSSI-
VESI PUTKI
VIEMÄRIIN



HUONETERMOSTAATTI SEINÄLLÄ

(=0/1 + min/med/max)

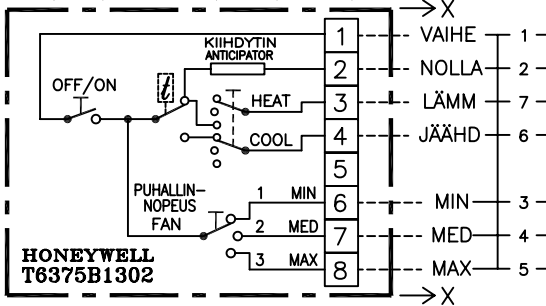
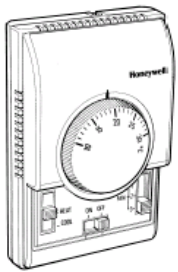

HONEYWELL
T6375B1302

MMO
7x1,5

—	= TEHDASJOHDOTUS (SÄHKÖ)
X	= URAKKARAJA, KAAPELIN ASENNUS JA KYTKENTÄ SÄHKÖURAKKA
---	= KAAPELOINTI "KENTÄLLÄ"
----	= JOHDOTUS "KENTÄLLÄ" SÄHKÖURAKKA
P	= URAKKARAJA, PUTKIEN ASENNUS JA KYTKENTÄ PUTKIURAKKA

Malli SIGMA ___ SH: Ilmanottoaukko TAKANA, puhallus ETEENPÄIN. KATTOASENNUS		
MALLI-KOKO	Sähköteho MAX-nopeus [kW]	Nimellisvirta MAX-nopeus [A]
224	0,184 kW	0,812 A
226	0,203 kW	0,880 A
228	0,241 kW	1,1 A